

PIN14 PIN2

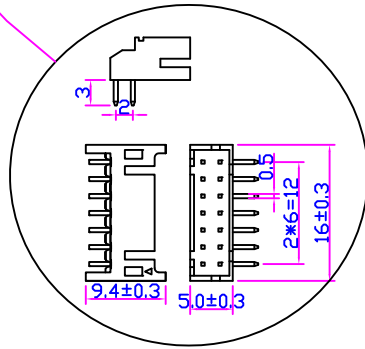

PIN14 PIN1

