



# TOYO LED ELECTRONICS LIMITED

Room 1610, Hong Kong Plaza, 188 Connaught Road West, Hong Kong.

Tel : (852) 2540 7288  
http://www.toyo-led.com

Fax : (852) 2517 1797  
E-mail : sales@toyo-led.com



**P/N: TY-A3535UVC-0.5W-275**

3.5\*3.5mm TOP SMD Series

# SPECIFICATION FOR CUSTOMER APPROVAL

**P/N: TY-A3535UVC-0.5W-275**

DATE : May 6, 2020

PREPARED BY : STEVEN

CONFIRMED BY :

**PLEASE CONFIRM & SIGN BACK THIS SHEET TO US**

**CUSTOMER:** \_\_\_\_\_

(COMPANY CHOP)

**APPROVAL BY:** \_\_\_\_\_

(SIGNATURE)



# TOYO LED ELECTRONICS LIMITED

Room 1610, Hong Kong Plaza, 188 Connaught Road West, Hong Kong.

Tel : (852) 2540 7288  
http://www.toyo-led.com

Fax : (852) 2517 1797  
E-mail : sales@toyo-led.com



## P/N: TY-A3535UVC-0.5W-275

3.5\*3.5mm TOP SMD Series

### ✧ Features:

- High power UVC LED
- Dimension 3.5mm\* 3.5mm\* 1.49mm
- ESD protection up to 2KV
- Typical viewing angle: 120°
- RoHS compliant
- Pb free
- Compliance with EU REACH
- Compliance Halogen Free  
(Br<900ppm,Cl<900ppm,Br+Cl<1500ppm)
- The TY-A3535UVC product series is a ceramic based LED with high quality and reliability that suitable for UV application.

### ✧ Description

The **Violet** source color devices are made with InGaN on sapphire Light Emitting Diode.

### ✧ Package Dimensions

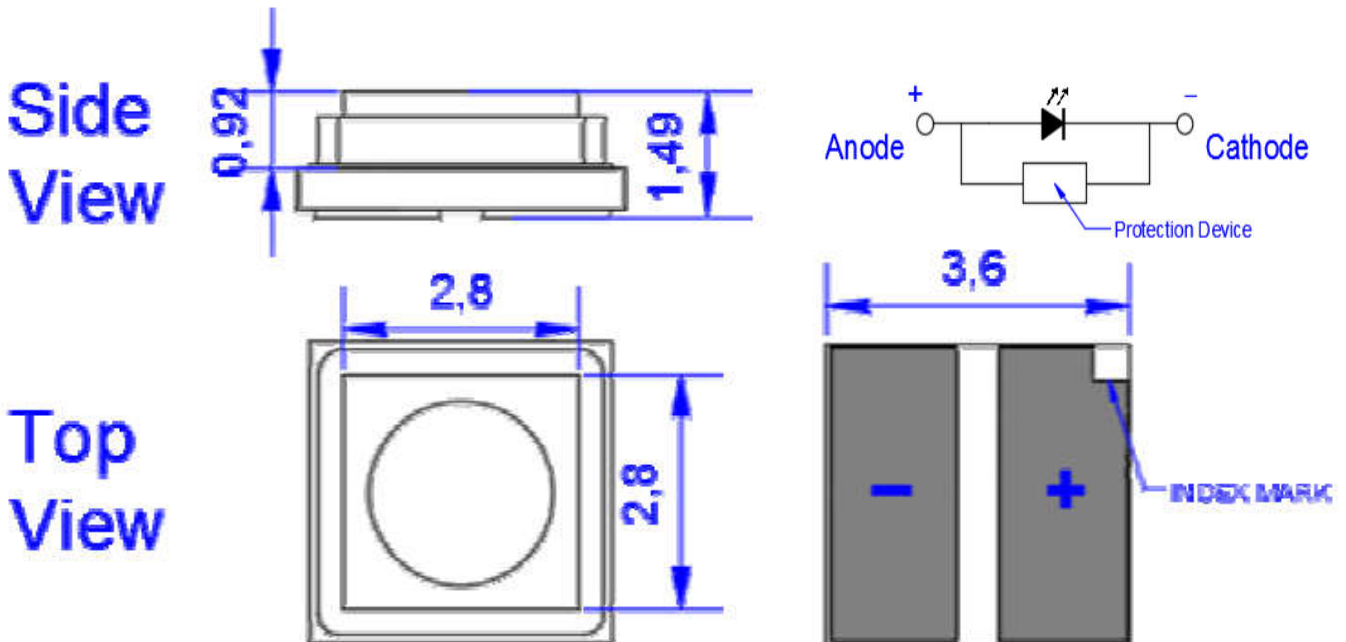

### NOTES:

1. All dimensions are in millimeter[unit];
2. Tolerance is $\pm 0.15$ mm unless other specified;
3. Specifications are subject to change without notice.



# TOYO LED ELECTRONICS LIMITED

Room 1610, Hong Kong Plaza, 188 Connaught Road West, Hong Kong.

Tel : (852) 2540 7288  
http://www.toyo-led.com

Fax : (852) 2517 1797  
E-mail : sales@toyo-led.com



## P/N: TY-A3535UVC-0.5W-275

3.5\*3.5mm TOP SMD Series

| Part No.             | Emitted Color | Lens Color  | Chip Material |
|----------------------|---------------|-------------|---------------|
| TY-A3535UVC-0.5W-275 | Violet        | Water Clear | InGaN         |

### ◇ Absolute Maximum Ratings(Ta=25°C)

| Parameter                    | Symbol | Ratings    | Unit |
|------------------------------|--------|------------|------|
| Max. DC Forward Current (mA) | IF     | 60         | mA   |
| Max. ESD Resistance          | VB     | 2000       | V    |
| Max. Junction Temperature    | TJ     | 70         | °C   |
| Thermal Resistance           | Rth    | 20         | °C/W |
| Operating Temperature        | TOpr   | -30 ~ +60  | °C   |
| Storage Temperature          | TStg   | -40 ~ +100 | °C   |

### ◇ Electrical/Optical Characteristics(Ta=25°C)

| Parameter                 | Symbol  | Min. | Typ. | Max. | Unit | Test Condition |
|---------------------------|---------|------|------|------|------|----------------|
| Forward Voltage           | VF      | 5.5  | 6.0  | 7.5  | V    | IF=60mA        |
| Power Radiant             | Φe      | 6.0  | 7.0  | 8.0  | mW   | IF=60mA        |
| Peak Wavelength           | WLP     | 270  | 275  | 280  | nm   | IF=60mA        |
| Reverse Current           | IR      | 0    | -    | 10   | μA   | VR=5V          |
| Half Wave Width           | HW      | 8    | -    | 12   | nm   | IF=60mA        |
| Viewing Angle             | 2θ1/2   | -    | -    | 120  | deg  | IF=60mA        |
| Recommend Forward Current | IF(rec) |      |      | 60   | mA   |                |

tolerance of measurement of forward voltage±0.1V



# TOYO LED ELECTRONICS LIMITED

Room 1610, Hong Kong Plaza, 188 Connaught Road West, Hong Kong.  
 Tel : (852) 2540 7288 Fax : (852) 2517 1797  
 http://www.toyo-led.com E-mail : sales@toyo-led.com



## P/N: TY-A3535UVC-0.5W-275

3.5\*3.5mm TOP SMD Series

### ◇ Typical Electro-Optical Characteristics Curves

( 25 ° Ambient Temperature Unless Otherwise Noted )

#### Spatial Distribution

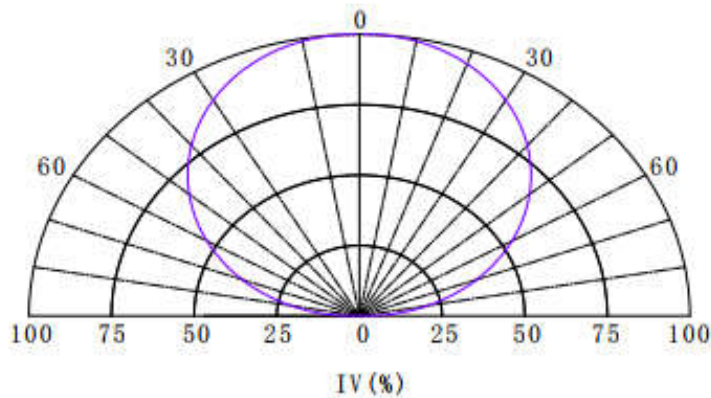

#### Typical electrical-optical Characteristics curves

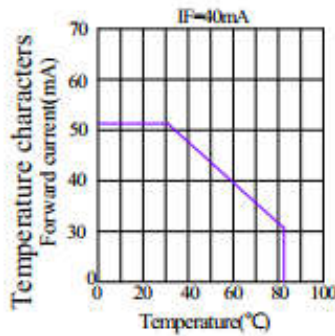
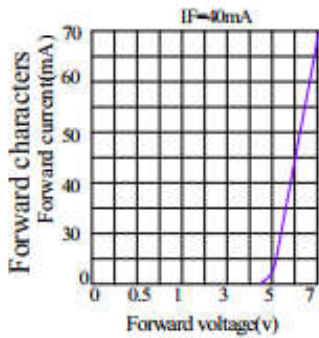

#### Notes:

The data are an typical presentation of the product, Contact customer service for details of technical information and warranty.  
 The product is sensitive to static antistatic operation environment is recommended  
 Products are shipped in either bulk bag package or taping.

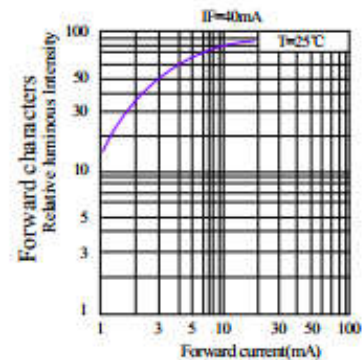
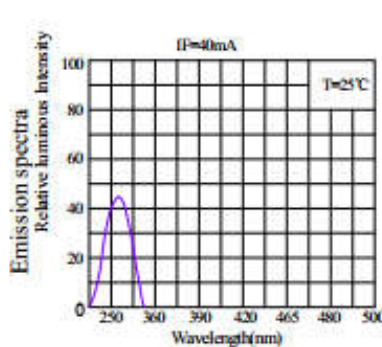
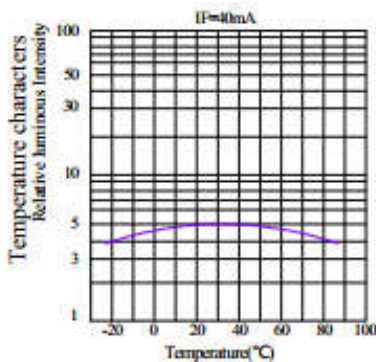



# TOYO LED ELECTRONICS LIMITED

Room 1610, Hong Kong Plaza, 188 Connaught Road West, Hong Kong.  
 Tel : (852) 2540 7288 Fax : (852) 2517 1797  
 http://www.toyo-led.com E-mail : sales@toyo-led.com



**P/N: TY-A3535UVC-0.5W-275**

3.5\*3.5mm TOP SMD Series

## ◇ Reliability Test Items And Conditions

| Type                   | Test Item                    | REF Standard          | Test Condition   | Note                 | Number of Damaged |
|------------------------|------------------------------|-----------------------|--|----------------------|-------------------|
| Environmental Sequence | Temperature Cycle            | JIS C 7021 (1997)A-4  | -20°C*30mins~25°C<br>*5mins~80°C * 30mins                | 100 cycles           | 0/100             |
|                        | High Humidity Heat Cycle     | JIS C 7021 (1997)A-5  | 30°C→65°C, RH= 90%<br>24hrs/1cycle                       | 10 cycles            | 0/100             |
|                        | High Temperature Storage     | JIS C 7021 (1997)B-10 | Ta= 80°C   | 1000h                | 0/100             |
|                        | Humidity Heat Storage        | JIS C 7021 (1997)B-11 | Ta=60°C RH=90%   | 1000h                | 0/100             |
|                        | Low Temperature Storage      | JIS C 7021 (1997)B-12 | Ta= -30°C  | 1000h                | 0/100             |
| Operation Sequence     | DC Operating Life            | JIS C 7035 (1985)     | Ta= 25°C, IF=40mA  | 1000h                | 0/100             |
|                        | High Humidity Heat Life Test | *                     | Ta=60°C RH=90%<br>IF=40mA                                | 500h                 | 0/100             |
|                        | Low Temperature Life Test    | *                     | Ta= -20°C, IF=40mA                                       | 1000h                | 0/100             |
| Destructive Sequence   | Resistance to Soldering Heat | JIS C 7021 (1997)A-11 | Tsol=180±5°C,10sec (3mm from the base of the epoxy bulb) | 1 time               | 0/20              |
|                        | Solderability                | JIS C 7021 (1997)A-2  | Tsol=170 ±5 °C ,5sec (Usingflux)                         | 1 time (over 95%)    | 0/20              |
|                        | Lead Pull/Bend Test          | JIS C 7021 (1997)A-11 | Load 2.5N (0.25kgf) 0°→90°→0°Bending 3 times             | No noticeable damage | 0/20              |

\*Refer to reliability test standard specification for in this line.

## ◇ SMT Reflow Soldering Instructions

Number of reflow process shall be than 2 times and cooling Process to normal temperature is required between first and second soldering process

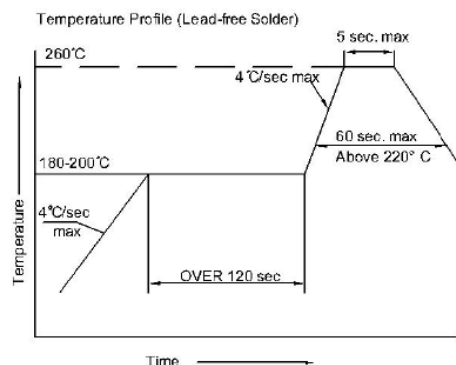
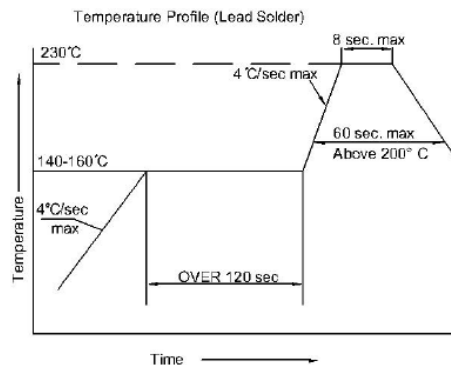



# TOYO LED ELECTRONICS LIMITED

Room 1610, Hong Kong Plaza, 188 Connaught Road West, Hong Kong.

Tel : (852) 2540 7288  
http://www.toyo-led.com

Fax : (852) 2517 1797  
E-mail : sales@toyo-led.com



## P/N: TY-A3535UVC-0.5W-275

3.5\*3.5mm TOP SMD Series

### ❖ Recommended Soldering Pad Dimensions

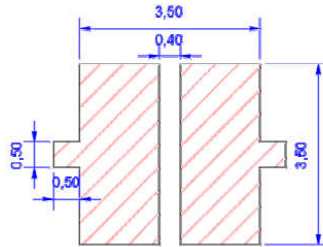

Recommended Soldering pad Layout  
(Unit: mm)

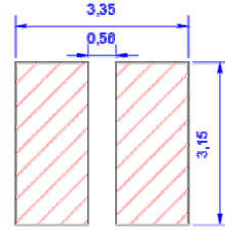

Recommended Soldering Mask Layout  
(Unit: mm)

### ❖ Tape Specification: 1,000PCS per reel

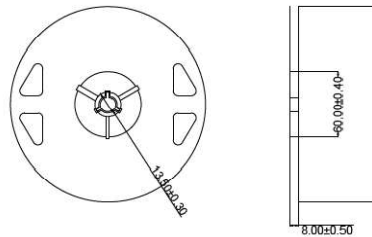

Feed Direction

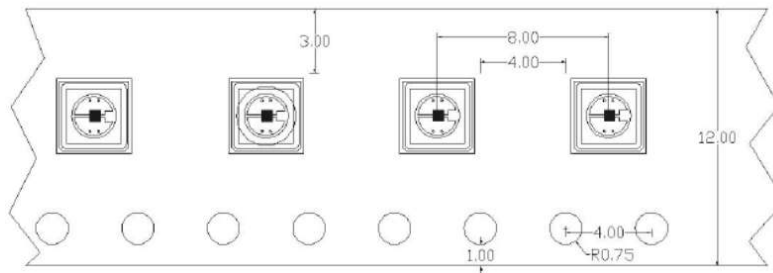
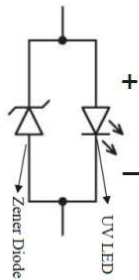

### ❖ Package Label

|   |            |
|---|------------|
| SMD LED   |            |
| PART NO: _____  | QA<br>Pass |
| LOT NO : _____  |            |
| Q' TY : _____   |            |
| VF : _____ IV : _____                                       |            |
| WL : _____ BIN: _____                                       | Pb         |
| DATA : _____  |            |
| TOYO LED ELECTRONICS LIMITED                                |            |
| Website: http://www.toyo-led.com E-mail: sales@toyo-led.com |            |



# TOYO LED ELECTRONICS LIMITED

Room 1610, Hong Kong Plaza, 188 Connaught Road West, Hong Kong.  
Tel : (852) 2540 7288 Fax : (852) 2517 1797  
http://www.toyo-led.com E-mail : sales@toyo-led.com



**P/N: TY-A3535UVC-0.5W-275**

3.5\*3.5mm TOP SMD Series

## ❖ Package & Shipping Instructions

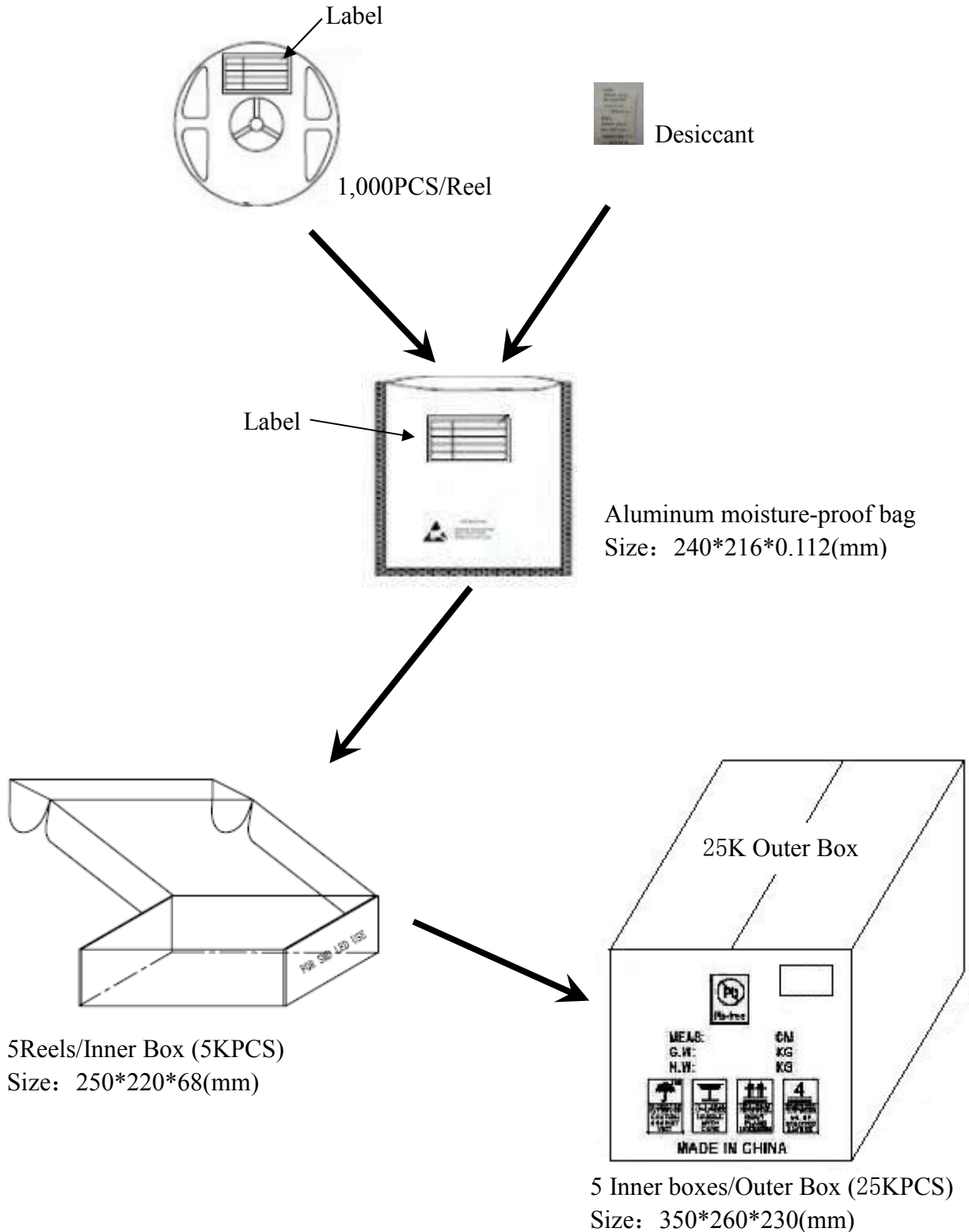



# TOYO LED ELECTRONICS LIMITED

Room 1610, Hong Kong Plaza, 188 Connaught Road West, Hong Kong.

Tel : (852) 2540 7288  
http://www.toyo-led.com

Fax : (852) 2517 1797  
E-mail : sales@toyo-led.com



## P/N: TY-A3535UVC-0.5W-275

3.5\*3.5mm TOP SMD Series

### Cautions

The LED's are devices which are materialized by combining blue LED's and special phosphors. Consequently the color of the LED's is changed a little by an operating current. Care should be taken after due consideration when using LED's.

#### (1) Moisture Proof Package:

When moisture is absorbed into package it may vaporize and expand during soldering. There is a possibility that this can cause exfoliation of the contacts and damage to the optical characteristics of the LED's. For this reason, the moisture proof package is used to keep moisture to a minimum in the package.

#### (2) Storage Conditions

Before opening the package:

The LED's should be kept at 30°C or less and 60%RH or less. The LED's should be used within a year. When storing the LED's. Moisture proof packaging with absorbent material (silica gel) is recommended.

After opening the package:

The LED's should be kept at 30°C or less and 50%RH or less. The LED's should be soldered within 168 hours (7days) after opening the package. If unused LED's remain, they should be stored in moisture proof packages, such as sealed containers with packages of moisture absorbent material (silica gel). It is also recommended to return the LED's to the original moisture proof bag and to reseal the moisture proof bag again. If the moisture absorbent material (silica gel) has faded away or the LED's have exceeded the storage time, baking treatment should be performed using the following conditions. Baking treatment: more than 48 hours at 65±5°C

LEDGUHON LED electrode and lead free are comprised of a silver plated copper alloy. The silver surface may be affected by environments which contain corrosive gases and so on. Please Avoid conditions which may cause the LED to corrode, tarnish or discolor. This corrosion or discoloration might lower solderability or might affect on optical characteristics. Please avoid rapid transitions in ambient temperature, especially in high humidity environments where condensation can occur.

#### (3) Heat Generation

Thermal design of the end product is of paramount importance. Please consider the heat generation of the LED when making the system design. The coefficient of temperature increase per input electric power is affected by the thermal resistance of the circuit board and density of LED placement on the board, as well as other components. It is necessary to avoid intense heat generation and operate within the maximum ratings given in this specification. The operating current should be decided after considering the ambient maximum temperature of LED's.

#### (4) Cleaning

It is recommended that isopropyl alcohol be used as a solvent for cleaning the LED's. when using other solvents, it should be confirmed beforehand whether the solvents will dissolve the package and the resin or not. Freon solvents should not be used to clean the LED's because of worldwide regulations. Do not clean the LED's by the ultrasonic. When it is absolutely necessary, the influence of ultrasonic cleaning on the LED's depends on factors such as ultrasonic power and the assembled condition. Before cleaning, a pre-test should be done to confirm whether any damage to the LED's will occur °C

#### (5) Static Electricity

Static electricity or surge voltage damages the LED's. It is recommended that a wrist band or an anti-electrostatic glove be used when handling the LED's. All devices, equipment and machinery must be properly grounded. It is





## TOYO LED ELECTRONICS LIMITED

Room 1610, Hong Kong Plaza, 188 Connaught Road West, Hong Kong.

Tel : (852) 2540 7288  
http://www.toyo-led.com

Fax : (852) 2517 1797  
E-mail : sales@toyo-led.com



### P/N: TY-A3535UVC-0.5W-275

3.5\*3.5mm TOP SMD Series

recommended that measures be taken against surge voltage to the equipment that mounts the LED's. When inspecting the final products in which LED's were assembled, it is recommended to check. Whether the assembled LED's are damaged by static electricity or not, it is easy to find static-damaged LED's by a light -on test or a VF test at a lower current (below 1mA is recommended). Damaged LED's will show some unusual characteristics such as the leak current remarkably increases, the forward voltage becomes lower, or the LED's do not light at the low current. Criteria ( $V_f > 2.0V$  at  $I_f = 0.5mA$ )

#### (6) Others

Care must be taken to ensure that the reverse voltage will not exceed the absolute maximum rating when using the LED's with matrix drive. The LED light output is strong enough to injure human eyes. Precautions must be taken to prevent looking directly at the LED's with unaided eyes for more than a few seconds. Flashing lights have been known to cause discomfort in people, you can prevent this by taking precautions during use. Also, people should be cautious when using equipment that has had LED's incorporated into it. The LED's described in this brochure are intended to be used for ordinary electronic equipment (such as office equipment, communications equipment, measurement instruments and household appliances) Consult TOYO LEDs sales staff in advance for information on the applications in which exceptional quality and reliability are required, particularly when the failure or malfunction of the LED's may directly jeopardize life or health (such as for airplanes, aerospace, submersible repeaters, nuclear reactor control systems, automobile, traffic control equipment, life support systems and safety devices). User shall not reverse engineer by disassembling or analysis of the LED's without having prior written consent from TOYO LEDs when defective LED's are found, the User shall inform TOYO LEDs directly before disassembling or analysis. The formal specifications must be exchanged and signed by both parties before large volume purchase begins. The appearance and specifications of the product may be modified for improvement without notice.