



TOYO LED ELECTRONICS LIMITED

Unit 10-11, 19/F, Metro Loft, 38 KwaiHei Street, Kwai Chung, N.T., Hong Kong
Tel : (852) 2540 7288 Fax : (852) 2517 1797
http://www.toyo-led.com E-mail : sales@toyo-led.com



P/N:TY-Y0603UR1-LS(0.95)

0603 package 1.6x0.8mm SMD LEDs with lens Series

✧ Features:

- 1.6*0.8*0.95mm
- Mono-color type
- Soldering methods :All SMT assembly methods
- Comply ROHS standard

✧ Description

The red source color devices are made with AlGaInP on sapphire Light Emitting Diode.

✧ Application

- LCD backlight
- Illuminations
- Indicator light

✧ Package Dimensions

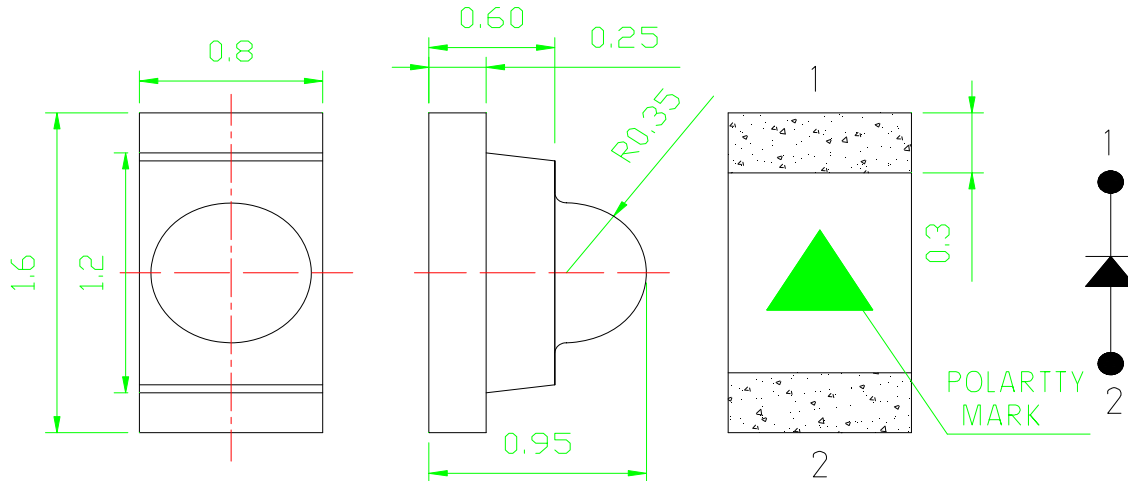

NOTES:

1. All dimensions are in millimeter[unit];
2. Tolerance is $\pm 0.1\text{mm}$ (0.004") especially other specified;
3. Specifications are subject to change without notice.



TOYO LED ELECTRONICS LIMITED

Unit 10-11, 19/F, Metro Loft, 38 KwaiHei Street, Kwai Chung, N.T., Hong Kong
 Tel : (852) 2540 7288 Fax : (852) 2517 1797
 http://www.toyo-led.com E-mail : sales@toyo-led.com



P/N:TY-Y0603UR1-LS(0.95)

0603 package 1.6x0.8mm SMD LEDs with lens Series

Part No.	Emitted Color	Lens Color	Chip Material
TY-Y0603UR1-LS(0.95)	Red	Water Clear	AlGaInP

✧ Absolute Maximum Ratings(Ta=25°C)

Item	Symbol	Maximum	Unit
Power Dissipation	PD	75	mW
Continuous Forward Current	I _{Fmax}	30	mA
Peak Forward Current(1/10 Duty Cycle 0.1ms Pulse Width)	I _{FP}	80	mA
Reverse Voltage	V _R	5	V
Operating TemperatureRange	T _{opr}	-40 to+85	°C
Storage TemperatureRange	T _{stg}	-40 to+85	°C
Lead Solder Temperature	Tsol	260°C for 3 seconds	

✧ Electrical/Optical Characteristics(Ta=25°C)

Item	Symbol	Condition	Min.	Typ.	Max	Unit
Forward Voltage	V _F	I _F =20mA	1.9	---	2.2	V
Luminous Intensity	I _V	I _F =20mA	200	400	---	mcd
Wavelength	λ	I _F =20mA	617	---	625	nm
Viewing Angle	2θ _{1/2}	I _F =20mA	---	35	---	Deg
Reverse Current	I _R	V _R =5V	---	---	10	uA



TOYO LED ELECTRONICS LIMITED

Unit 10-11, 19/F, Metro Loft, 38 KwaiHei Street, Kwai Chung, N.T., Hong Kong
 Tel : (852) 2540 7288 Fax : (852) 2517 1797
 http://www.toyo-led.com E-mail : sales@toyo-led.com



P/N:TY-Y0603UR1-LS(0.95)

0603 package 1.6x0.8mm SMD LEDs with lens Series

✧ Typical Electro-Optical Characteristics Curves

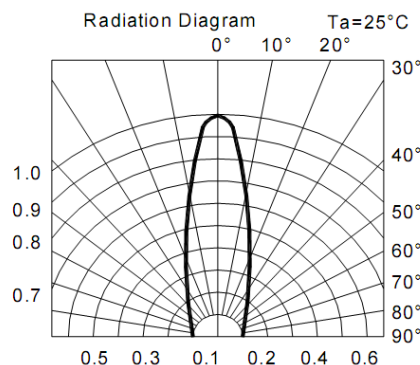
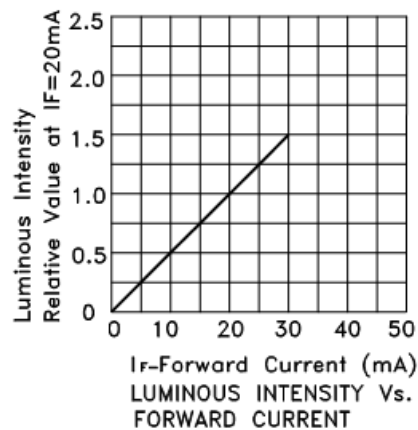
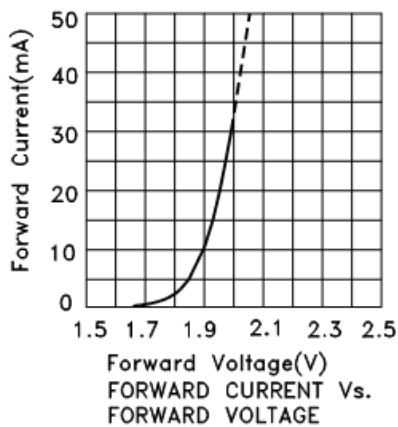
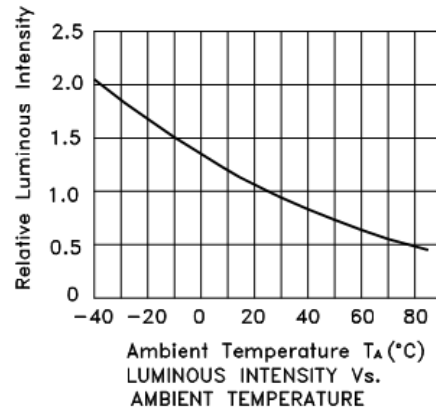
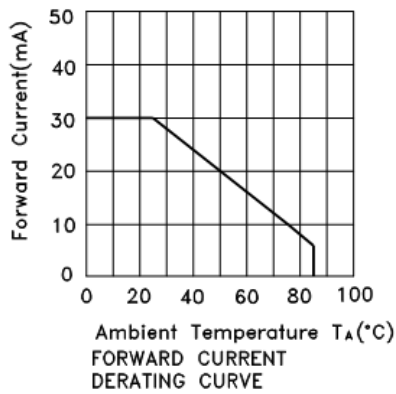
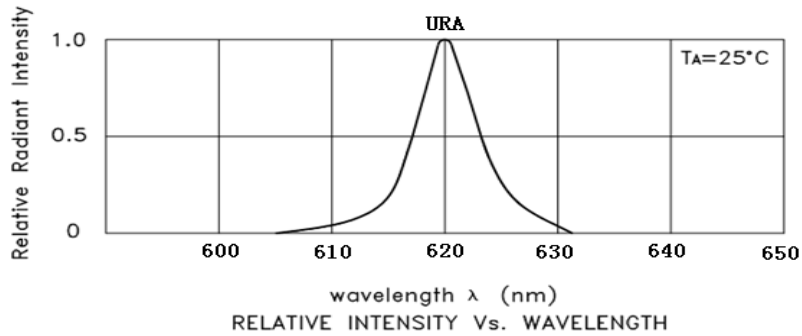



TOYO LED ELECTRONICS LIMITED

Unit 10-11, 19/F, Metro Loft, 38 KwaiHei Street, Kwai Chung, N.T., Hong Kong
 Tel : (852) 2540 7288 Fax : (852) 2517 1797
 http://www.toyo-led.com E-mail : sales@toyo-led.com



P/N:TY-Y0603UR1-LS(0.95)

0603 package 1.6x0.8mm SMD LEDs with lens Series

◇ Reliability Test Items And Conditions

NO.	Item	Test Condition	Test Hr/cycle/time	Sample Q'ty	Ac/Re
1	Reflow	TEMP:260±5°C; Min.5Sec	6 min	22pcs	0/1
2	Temperature Cycle	H:+100°C 30mins To(5mins) L:-40°C 30mins	100 cycles	22pcs	0/1
3	Thermal Shock	H:+100°C 15mins L:-40°C 15mins	500 cycles	22pcs	0/1
4	Low Temperature Storage	TEMP:-40°C	1000hrs	22pcs	0/1
5	DC Operating Life	IF=20MA	1000hrs	22pcs	0/1
6	High Temperature	85°C	1000hrs	22pcs	0/1
7	High Humidity	85%R.H.	1000hrs	22pcs	0/1

◇ SMT Reflow Soldering Instructions

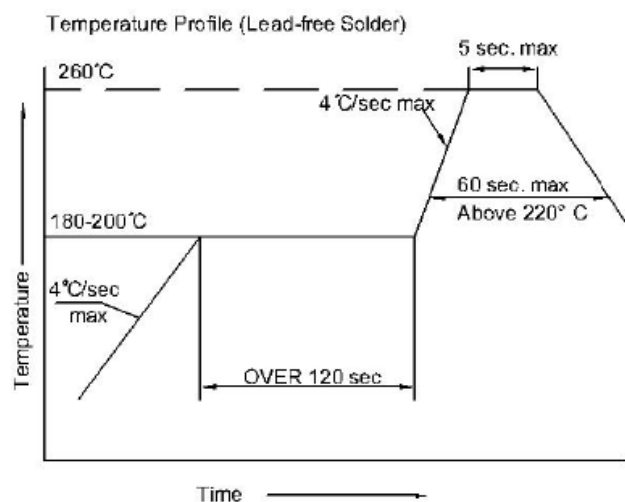
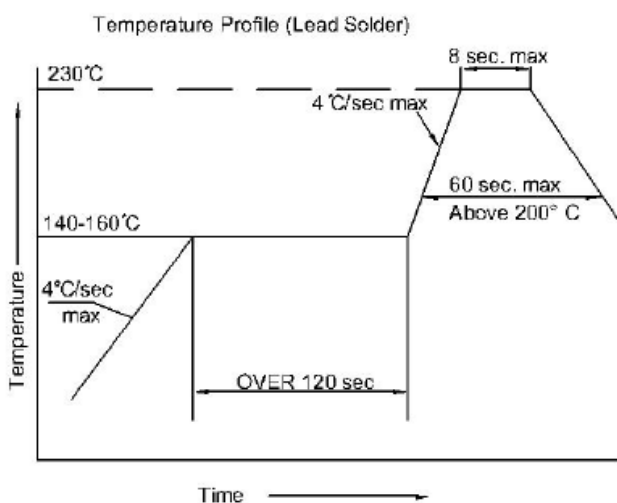



TOYO LED ELECTRONICS LIMITED

Unit 10-11, 19/F, Metro Loft, 38 KwaiHei Street, Kwai Chung, N.T., Hong Kong
Tel : (852) 2540 7288 Fax : (852) 2517 1797
http://www.toyo-led.com E-mail : sales@toyo-led.com



P/N:TY-Y0603UR1-LS(0.95)

0603 package 1.6x0.8mm SMD LEDs with lens Series

◇ Recommended Soldering Pad Dimensions

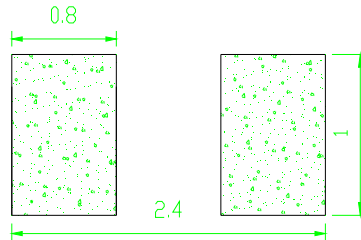

◇ Tape Specification:3,000PCS per reel

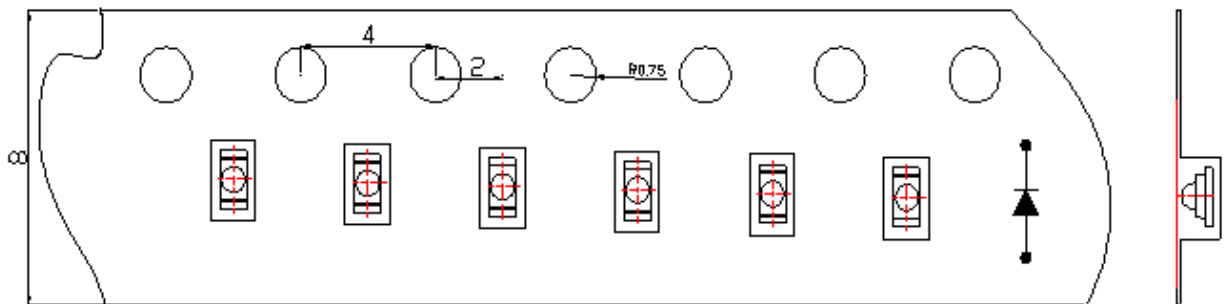
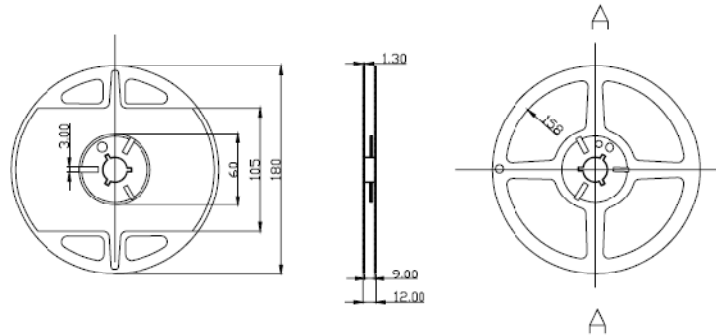

◇ Package Label

SMD LED	
PART NO: _____	QA Pass
LOT NO : _____	
Q' TY : _____	Pb
VF : _____ IV : _____	
WL : _____ BIN: _____	
DATA : _____	
TOYO LED ELECTRONICS LIMITED	
Website: http://www.toyo-led.com E-mail: sales@toyo-led.com	



TOYO LED ELECTRONICS LIMITED

Unit 10-11, 19/F, Metro Loft, 38 KwaiHei Street, Kwai Chung, N.T., Hong Kong
Tel : (852) 2540 7288 Fax : (852) 2517 1797
http://www.toyo-led.com E-mail : sales@toyo-led.com



P/N:TY-Y0603UR1-LS(0.95)

0603 package 1.6x0.8mm SMD LEDs with lens Series

❖ Package & Shipping Instructions

