



# TOYO LED ELECTRONICS LIMITED

Unit 10-11, 19/F, Metro Loft, 38 KwaiHei Street, Kwai Chung, N.T., Hong Kong  
Tel : (852) 2540 7288 Fax : (852) 2517 1797  
http://www.toyo-led.com E-mail : sales@toyo-led.com



## P/N:TY-Y0603UG1-LS(0.95)

0603 package 1.6x0.8mm SMD LEDs with lens Series

### ✧ Features:

- 1.6\*0.8\*0.95mm
- Mono-color type
- Soldering methods :All SMT assembly methods
- Comply ROHS standard

### ✧ Description

The Yellow Green source color devices are made with **AlGaInP** on sapphire Light Emitting Diode.

### ✧ Application

- LCD backlight
- Illuminations
- Indicator light

### ✧ Package Dimensions

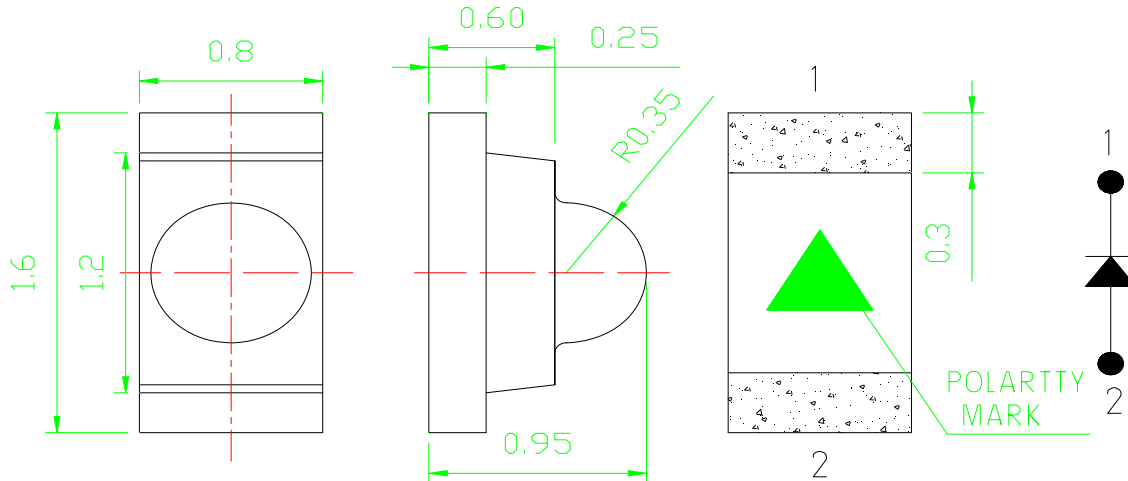

### NOTES:

1. All dimensions are in millimeter[unit];
2. Tolerance is  $\pm 0.1\text{mm}$  ( $0.004''$ ) especially other specified;
3. Specifications are subject to change without notice.



# TOYO LED ELECTRONICS LIMITED

Unit 10-11, 19/F, Metro Loft, 38 KwaiHei Street, Kwai Chung, N.T., Hong Kong  
 Tel : (852) 2540 7288 Fax : (852) 2517 1797  
 http://www.toyo-led.com E-mail : sales@toyo-led.com



## P/N:TY-Y0603UG1-LS(0.95)

0603 package 1.6x0.8mm SMD LEDs with lens Series

Part No.	Emitted Color	Lens Color	Chip Material
TY-Y0603UG1-LS(0.95)	Yellow Green	Water Clear	AlGaInP

### ❖ Absolute Maximum Ratings(Ta=25°C)

Item	Symbol	Maximum	Unit
Power Dissipation	PD	75	mW
Continuous Forward Current	I <sub>Fmax</sub>	25	mA
Peak Forward Current(1/10 Duty Cycle 0.1ms Pulse Width)	I <sub>FP</sub>	80	mA
Reverse Voltage	V <sub>R</sub>	5	V
Operating TemperatureRange	T <sub>opr</sub>	-40 to+85	°C
Storage TemperatureRange	T <sub>stg</sub>	-40 to+85	°C
Lead Solder Temperature	Tsol	260°C for 3 seconds	

### ❖ Electrical/Optical Characteristics(Ta=25°C)

Item	Symbol	Condition	Min.	Typ.	Max	Unit
Forward Voltage	V <sub>F</sub>	I <sub>F</sub> =20mA	1.9	---	2.2	V
Luminous Intensity	I <sub>V</sub>	I <sub>F</sub> =20mA	70	150	---	mcd
Wavelength	λ	I <sub>F</sub> =20mA	566	---	572	nm
Viewing Angle	2θ <sub>1/2</sub>	I <sub>F</sub> =20mA	---	35	---	Deg
Reverse Current	I <sub>R</sub>	V <sub>R</sub> =5V	---	---	10	uA



# TOYO LED ELECTRONICS LIMITED

Unit 10-11, 19/F, Metro Loft, 38 KwaiHei Street, Kwai Chung, N.T., Hong Kong  
 Tel : (852) 2540 7288 Fax : (852) 2517 1797  
 http://www.toyo-led.com E-mail : sales@toyo-led.com



**P/N:TY-Y0603UG1-LS(0.95)**

0603 package 1.6x0.8mm SMD LEDs with lens Series

## ✧ Typical Electro-Optical Characteristics Curves

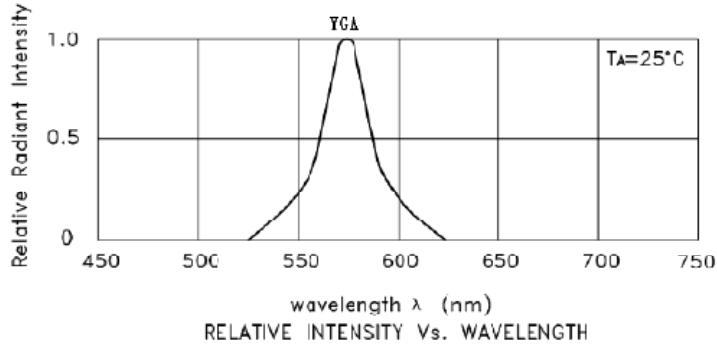

Yellow green

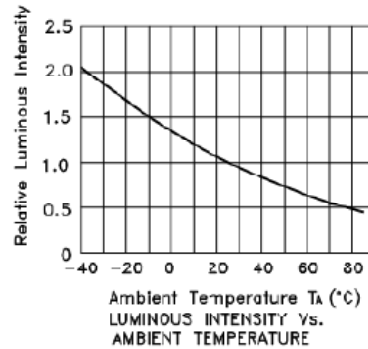
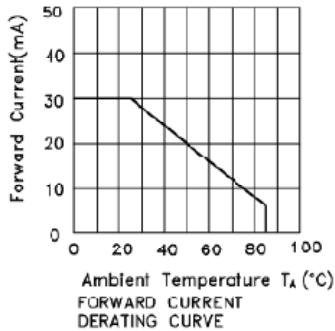
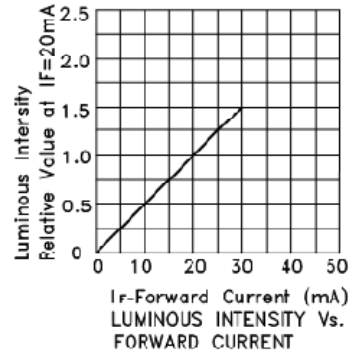
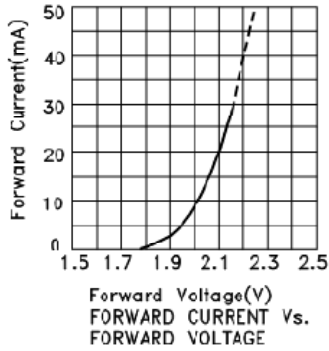

Radiation Diagram  $T_a=25^\circ\text{C}$

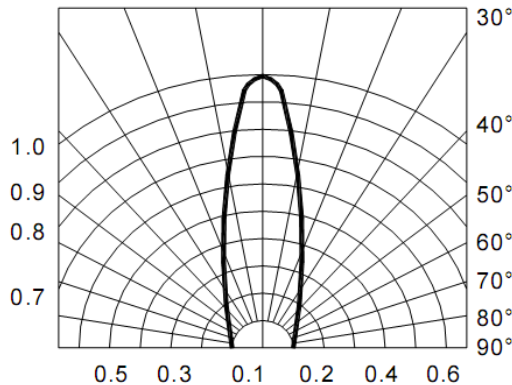



# TOYO LED ELECTRONICS LIMITED

Unit 10-11, 19/F, Metro Loft, 38 KwaiHei Street, Kwai Chung, N.T., Hong Kong  
 Tel : (852) 2540 7288 Fax : (852) 2517 1797  
 http://www.toyo-led.com E-mail : sales@toyo-led.com



## P/N:TY-Y0603UG1-LS(0.95)

0603 package 1.6x0.8mm SMD LEDs with lens Series

### ◇ Reliability Test Items And Conditions

NO.	Item	Test Condition	Test Hr/cycle/time	Sample Q'ty	Ac/Re
1	Reflow	TEMP:260±5°C; Min.5Sec	6 min	22pcs	0/1
2	Temperature Cycle	H:+100°C 30mins To(5mins) L:-40°C 30mins	100 cycles	22pcs	0/1
3	Thermal Shock	H:+100°C 15mins L:-40°C 15mins	500 cycles	22pcs	0/1
4	Low Temperature Storage	TEMP:-40°C	1000hrs	22pcs	0/1
5	DC Operating Life	IF=20MA	1000hrs	22pcs	0/1
6	High Temperature	85°C	1000hrs	22pcs	0/1
7	High Humidity	85%R.H.	1000hrs	22pcs	0/1

### ◇ SMT Reflow Soldering Instructions

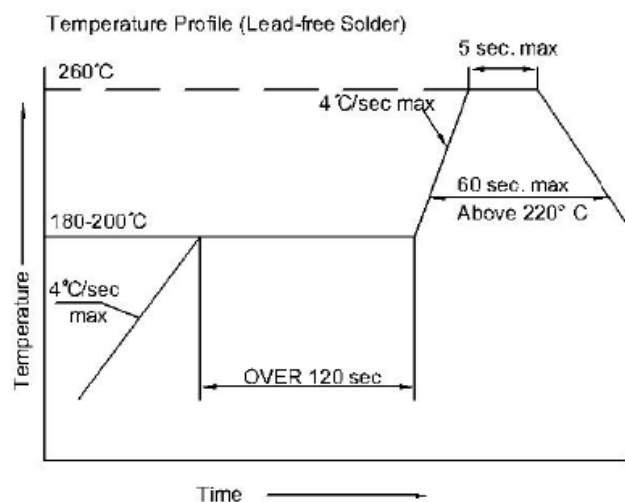
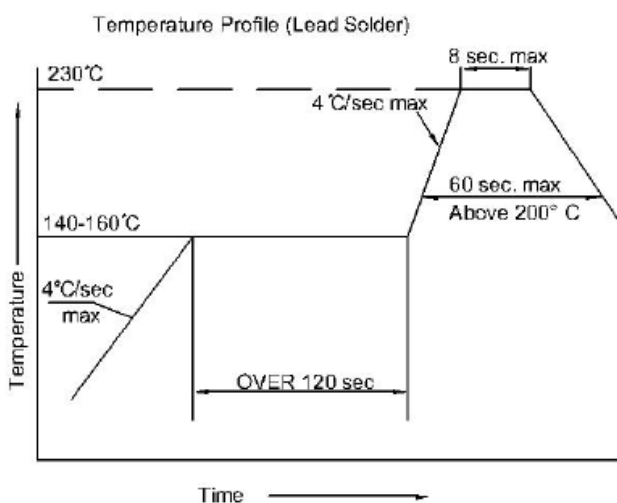



# TOYO LED ELECTRONICS LIMITED

Unit 10-11, 19/F, Metro Loft, 38 KwaiHei Street, Kwai Chung, N.T., Hong Kong  
Tel : (852) 2540 7288 Fax : (852) 2517 1797  
http://www.toyo-led.com E-mail : sales@toyo-led.com



## P/N:TY-Y0603UG1-LS(0.95)

0603 package 1.6x0.8mm SMD LEDs with lens Series

### ◇ Recommended Soldering Pad Dimensions

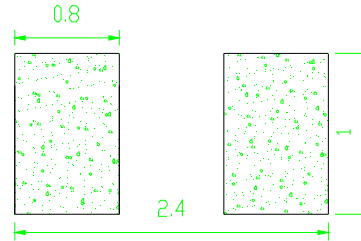

### ◇ Tape Specification:3,000PCS per reel

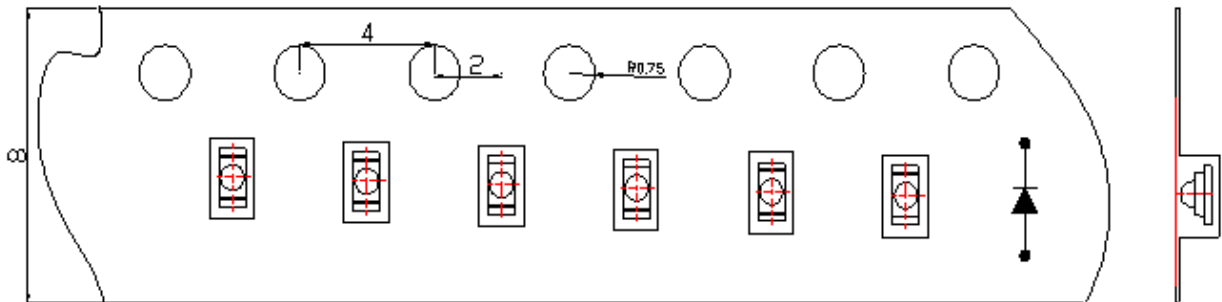
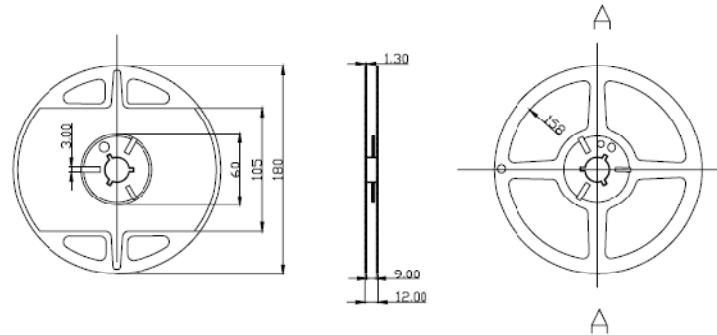

### ◇ Package Label

SMD LED	
PART NO: _____	QA Pass
LOT NO : _____	
Q' TY : _____	
VF : _____ IV : _____	
WL : _____ BIN: _____	Pb
DATA : _____	
TOYO LED ELECTRONICS LIMITED	
Website:http://www.toyo-led.com E-mail:sales@toyo-led.com	



# TOYO LED ELECTRONICS LIMITED

Unit 10-11, 19/F, Metro Loft, 38 KwaiHei Street, Kwai Chung, N.T., Hong Kong  
Tel : (852) 2540 7288 Fax : (852) 2517 1797  
http://www.toyo-led.com E-mail : sales@toyo-led.com



**P/N:TY-Y0603UG1-LS(0.95)**

0603 package 1.6x0.8mm SMD LEDs with lens Series

## ❖ Package & Shipping Instructions

