



TOYO LED ELECTRONICS LIMITED

Room 1610, Hong Kong Plaza, 188 Connaught Road West, Hong Kong.

Tel : (852) 2540 7288
http://www.toyo-led.com

Fax : (852) 2517 1797
E-mail : sales@toyo-led.com



P/N: TY-L0805PG1(0.80)

0805 Package 2.0*1.25mm Surface Mount LEDs Series

◆ Features:

- 2.0*1.25*0.8 mm
- Mono-color type
- Soldering methods :All SMT assembly methods
- Comply ROHS standard

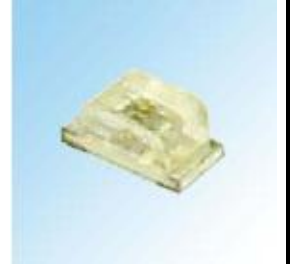

◆ Description

The Pure Green source color devices are made with **InGaN** on sapphire Light Emitting Diode.

◆ Application

- Optical indicator
- Indicator and backlighting in telephone and fax
- Flat backlight for LCD, switch and symbol
- Light pipe application
- General use

◆ Package Dimensions

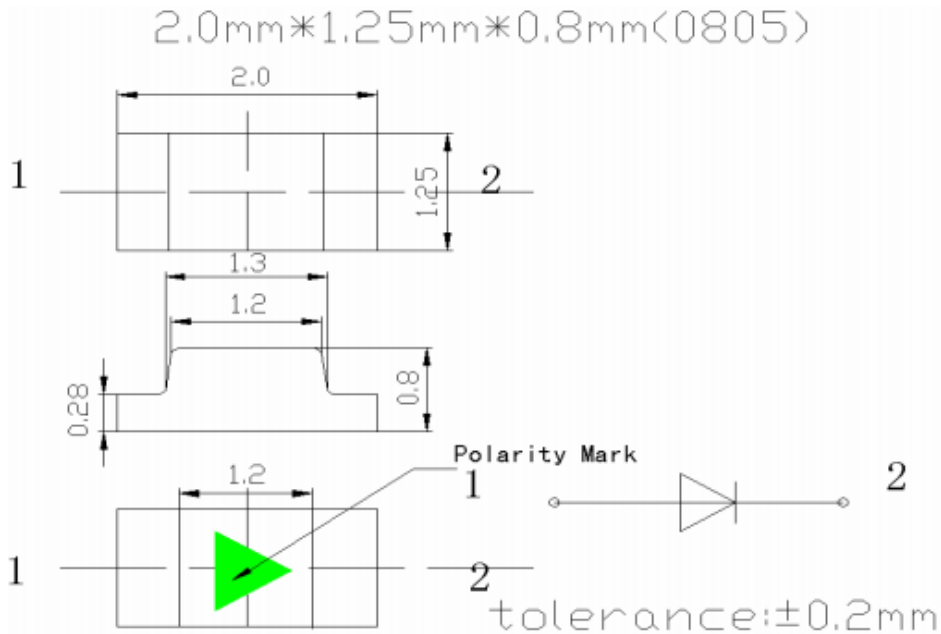

NOTES:

1. All dimensions are in millimeter[unit];
2. Tolerance is ±0.05mm unless other specified;
3. Specifications are subject to change without notice.



TOYO LED ELECTRONICS LIMITED

Room 1610, Hong Kong Plaza, 188 Connaught Road West, Hong Kong.

Tel : (852) 2540 7288
http://www.toyo-led.com

Fax : (852) 2517 1797
E-mail : sales@toyo-led.com



P/N: TY-L0805PG1(0.80)

0805 Package 2.0*1.25mm Surface Mount LEDs Series

| Part No. | Emitted Color | Len's Color | Chip Material |
|-------------------|---------------|-------------|---------------|
| TY-L0805PG1(0.80) | Pure Green | Water clear | InGaN |

✧ Absolute Maximum Ratings(Ta=25°C)

| Item | Symbol | Maximum | Unit |
|---|-------------------|----------------------|------|
| Power Dissipation | PD | 105 | mW |
| Continuous Forward Current | I _{Fmax} | 30 | mA |
| Peak Forward Current(1/10 Duty Cycle 0.1ms Pulse Width) | I _{FP} | 100 | mA |
| Reverse Voltage | V _R | 5 | V |
| Operating Temperature Range | T _{opr} | -40 to+85 | °C |
| Storage Temperature Range | T _{stg} | -40 to+85 | °C |
| Lead Solder Temperature | Tsol | 260 °C for 3 seconds | |

✧ Electrical/Optical Characteristics(Ta=25°C)

| Item | Symbol | Condition | Min. | Typ. | Max | Unit |
|--------------------|-------------------|----------------------|------|------|-----|------|
| Forward Voltage | V _F | I _F =20mA | 2.8 | --- | 3.4 | V |
| Luminous Intensity | I _v | I _F =20mA | 250 | 300 | --- | mcd |
| Wavelength | λ | I _F =20mA | 515 | 517 | --- | nm |
| Viewing Angle | 2θ _{1/2} | I _F =20mA | -- | 120 | -- | Deg |
| Reverse Current | I _R | V _R =5V | -- | 5 | 10 | uA |



TOYO LED ELECTRONICS LIMITED

Room 1610, Hong Kong Plaza, 188 Connaught Road West, Hong Kong.

Tel : (852) 2540 7288
http://www.toyo-led.com

Fax : (852) 2517 1797
E-mail : sales@toyo-led.com



P/N: TY-L0805PG1(0.80)

0805 Package 2.0*1.25mm Surface Mount LEDs Series

◇ Typical Electro-Optical Characteristics Curves

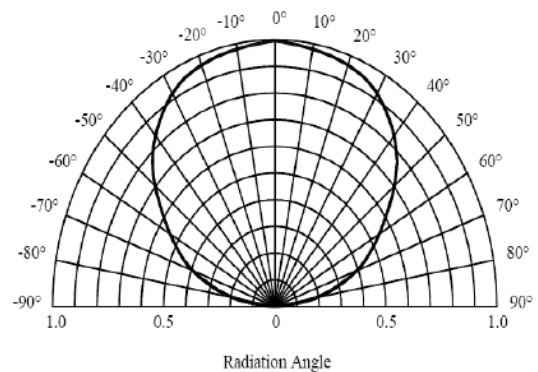
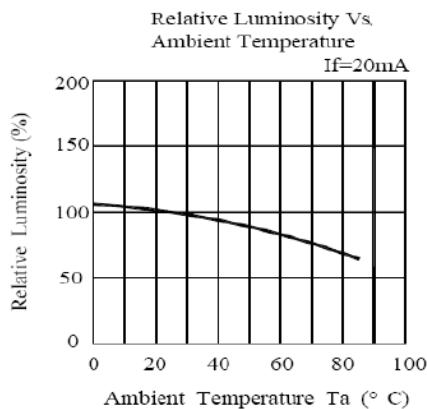
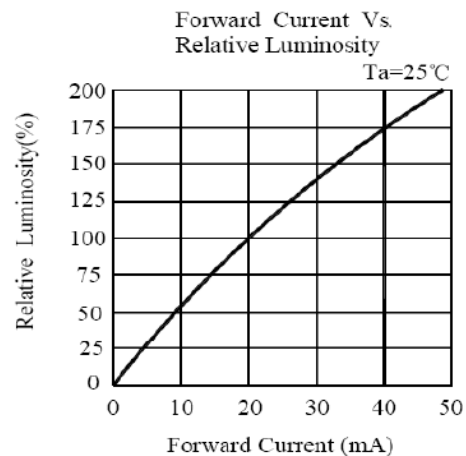
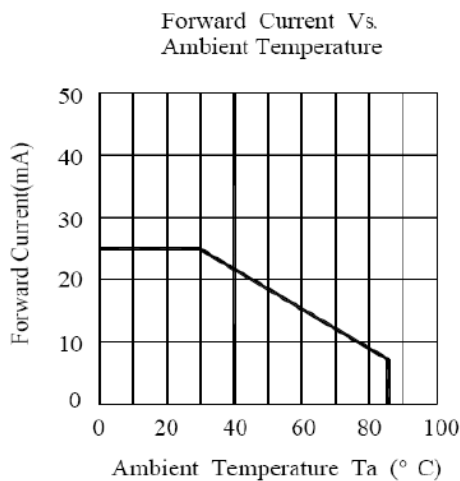
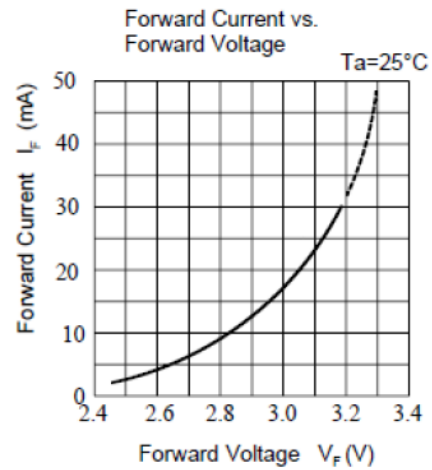
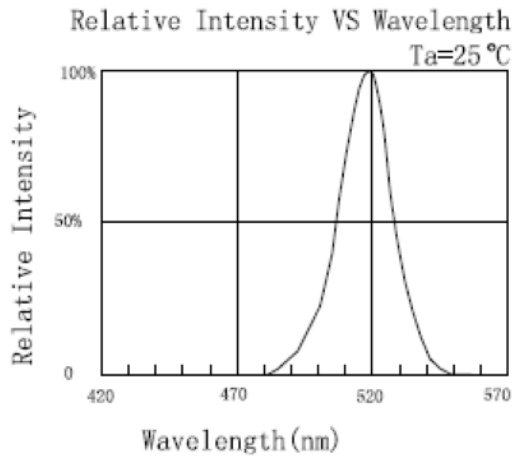



TOYO LED ELECTRONICS LIMITED

Room 1610, Hong Kong Plaza, 188 Connaught Road West, Hong Kong.
 Tel : (852) 2540 7288 Fax : (852) 2517 1797
 http://www.toyo-led.com E-mail : sales@toyo-led.com



P/N: TY-L0805PG1(0.80)

0805 Package 2.0*1.25mm Surface Mount LEDs Series

◇ Reliability Test Items And Conditions

| NO. | Item | Test Condition | Test Hr/cycle/time | Sample Q'ty | Ac/Re |
|-----|-------------------------|--|--------------------|-------------|-------|
| 1 | Reflow | TEMP:260±5°C; Min.5Sec | 6 min | 22pcs | 0/1 |
| 2 | Temperature Cycle | H:+100°C 15mins To(5mins) L:-40°C 15mins | 300 cycles | 22pcs | 0/1 |
| 3 | Thermal Shock | H:+100°C 15mins To(5mins) L:-40°C 15mins | 300 cycles | 22pcs | 0/1 |
| 4 | Low Temperature Storage | TEMP:-40°C | 1000hrs | 22pcs | 0/1 |
| 5 | DC Operating Life | IF=20MA | 1000hrs | 22pcs | 0/1 |
| 6 | High Temperature | 85°C | 1000hrs | 22pcs | 0/1 |
| 7 | High Humidity | 85%R.H. | 1000hrs | 22pcs | 0/1 |

◇ SMT Reflow Soldering Instructions

Number of reflow process shall be than 2 times and cooling
 Process to normal temperature is required between first and second
 soldering process

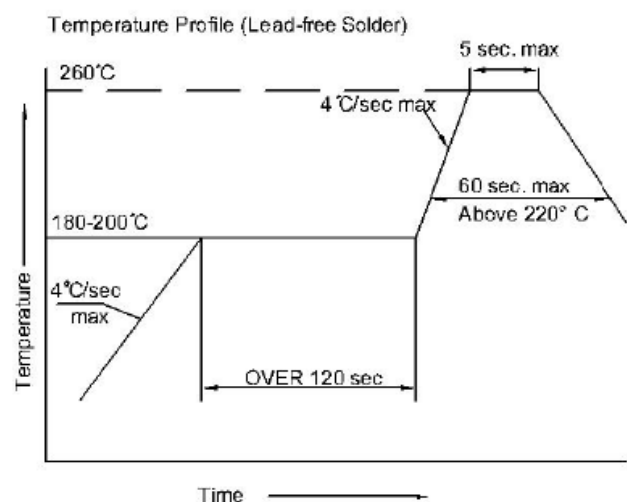
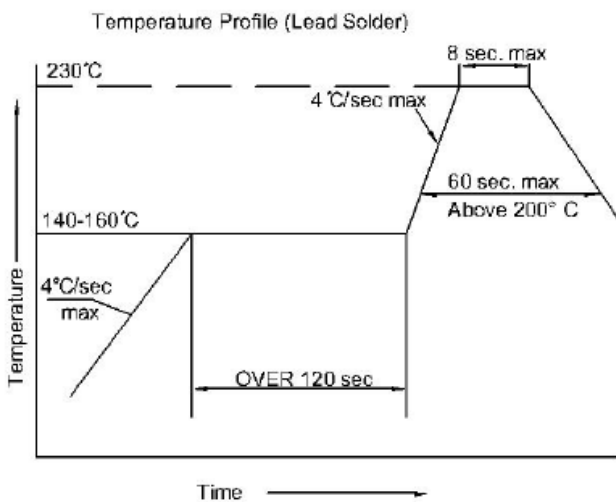



TOYO LED ELECTRONICS LIMITED

Room 1610, Hong Kong Plaza, 188 Connaught Road West, Hong Kong.
Tel : (852) 2540 7288 Fax : (852) 2517 1797
http://www.toyo-led.com E-mail : sales@toyo-led.com



P/N: TY-L0805PG1(0.80)

0805 Package 2.0*1.25mm Surface Mount LEDs Series

❖ Recommended Soldering Pad Dimensions

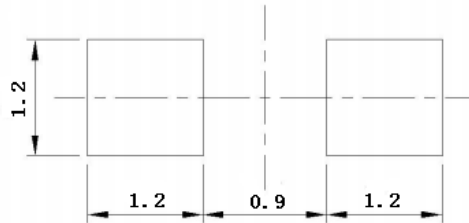

❖ Tape Specification: 3,000PCS per reel

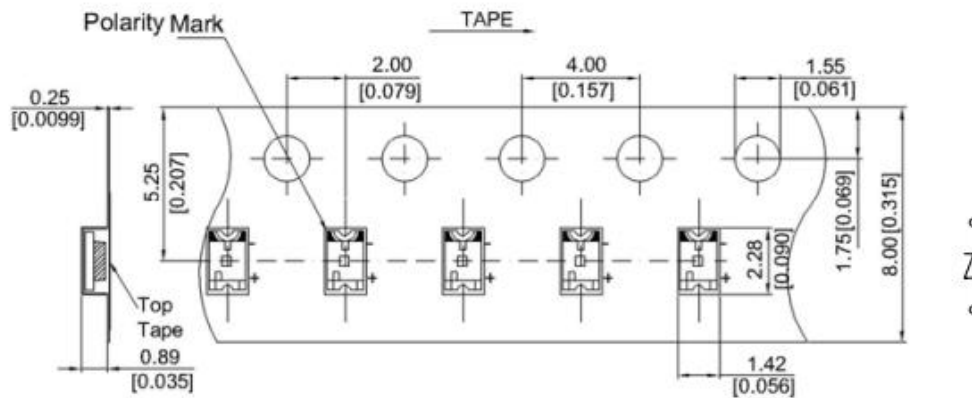
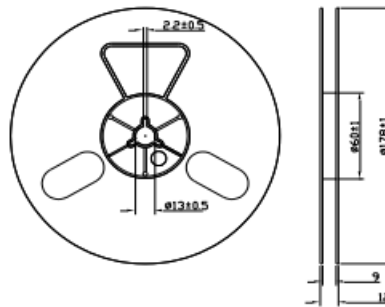

❖ Package Label

| | |
|---|------------|
| SMD LED | |
| PART NO: _____ | QA Pass |
| LOT NO : _____ | |
| Q' TY : _____ | |
| VF : _____ IV : _____ | |
| WL : _____ BIN: _____ | Pb |
| DATA : _____ | |
| TOYO LED ELECTRONICS LIMITED Website: http://www.toyo-led.com E-mail: sales@toyo-led.com | |



TOYO LED ELECTRONICS LIMITED

Room 1610, Hong Kong Plaza, 188 Connaught Road West, Hong Kong.

Tel : (852) 2540 7288
http://www.toyo-led.com

Fax : (852) 2517 1797
E-mail : sales@toyo-led.com



P/N: TY-L0805PG1(0.80)

0805 Package 2.0*1.25mm Surface Mount LEDs Series

❖ Package & Shipping Instructions

