



# TOYO LED ELECTRONICS LIMITED

Room 1610, Hong Kong Plaza, 188 Connaught Road West, Hong Kong.

Tel : (852) 2540 7288  
http://www.toyo-led.com

Fax : (852) 2517 1797  
E-mail : sales@toyo-led.com



## P/N: TY-L0603CW1(0.40)

0603 Package 1.6\*0.8mm Surface Mount LEDs Series

### ✧ Features:

- 1.6\*0.8\*0.4 mm
- Mono-color type
- Soldering methods :All SMT assembly methods
- Comply ROHS standard

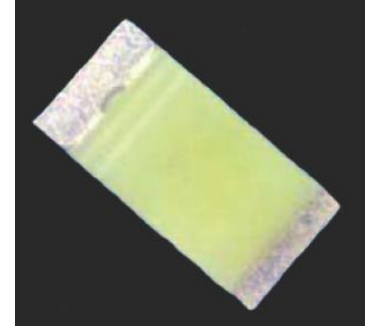

### ✧ Description

The Blue source color devices are made with **InGaN** on sapphire Light Emitting Diode.

### ✧ Application

- LCD backlight
- Illuminations

### ✧ Package Dimensions

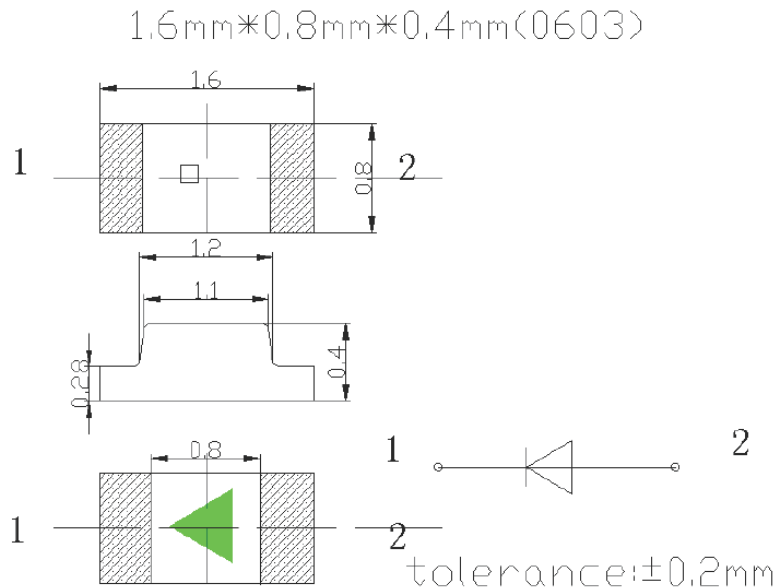

### NOTES:

1. All dimensions are in millimeter[unit];
2. Tolerance is ±0.1mm(0.004") unless other specified;
3. Specifications are subject to change without notice.



# TOYO LED ELECTRONICS LIMITED

Room 1610, Hong Kong Plaza, 188 Connaught Road West, Hong Kong.

Tel : (852) 2540 7288  
http://www.toyo-led.com

Fax : (852) 2517 1797  
E-mail : sales@toyo-led.com



## P/N: TY-L0603CW1(0.40)

0603 Package 1.6\*0.8mm Surface Mount LEDs Series

Part No.	Emitted Color	Lens Color	Chip Material
TY-L0603CW1(0.40)	Cool White	Yellow Diffused	InGaN

### ❖ Absolute Maximum Ratings(Ta=25°C)

Item	Symbol	Maximum	Unit
Power Dissipation	PD	114	mW
Continuous Forward Current	I <sub>Fmax</sub>	30	mA
Peak Forward Current(1/10 Duty Cycle 0.1ms Pulse Width)	I <sub>FP</sub>	150	mA
Reverse Voltage	V <sub>R</sub>	5	V
Operating Temperature Range	T <sub>opr</sub>	-40 to+85	°C
Storage Temperature Range	T <sub>stg</sub>	-40 to+85	°C
Lead Solder Temperature	Tsol	260 °C for 3 seconds	

### ❖ Electrical/Optical Characteristics(Ta=25°C)

Item	Symbol	Condition	Min.	Typ.	Max	Unit
Forward Voltage	V <sub>F</sub>	I <sub>F</sub> =20mA	2.8	--	3.6	V
Luminous Intensity	I <sub>V</sub>	I <sub>F</sub> =20mA	370	--	530	mcd
Color Temperature	T <sub>c</sub>	I <sub>F</sub> =20mA	7000	--	10000	K
Viewing Angle	2θ <sub>1/2</sub>	I <sub>F</sub> =20mA	---	120	---	Deg
Reverse Current	I <sub>R</sub>	V <sub>R</sub> =5V	---	---	10	uA



# TOYO LED ELECTRONICS LIMITED

Room 1610, Hong Kong Plaza, 188 Connaught Road West, Hong Kong.  
 Tel : (852) 2540 7288 Fax : (852) 2517 1797  
 http://www.toyo-led.com E-mail : sales@toyo-led.com



**P/N: TY-L0603CW1(0.40)**

0603 Package 1.6\*0.8mm Surface Mount LEDs Series

## ◇ Typical Electro-Optical Characteristics Curves

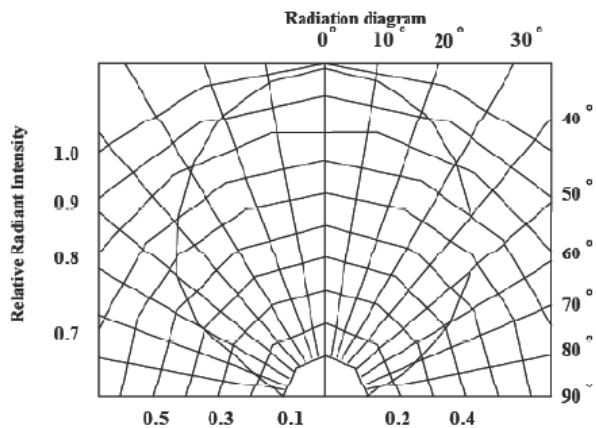
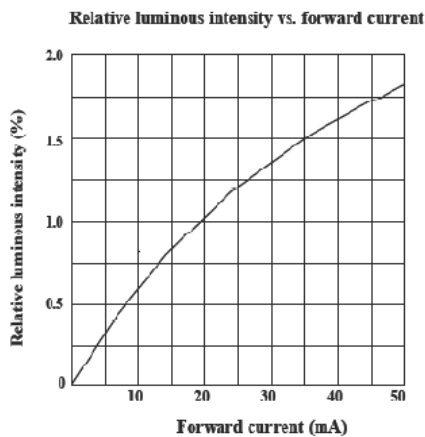
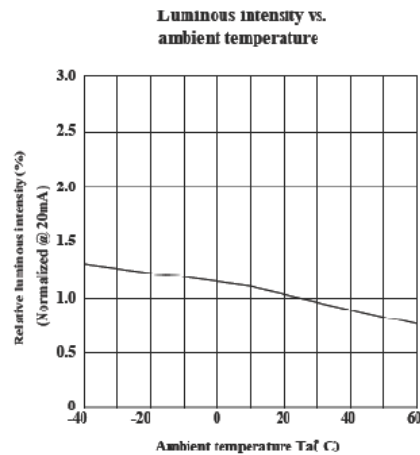
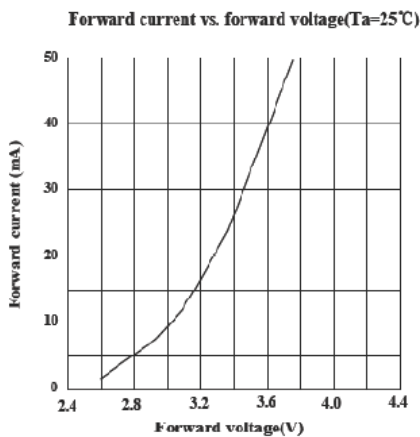
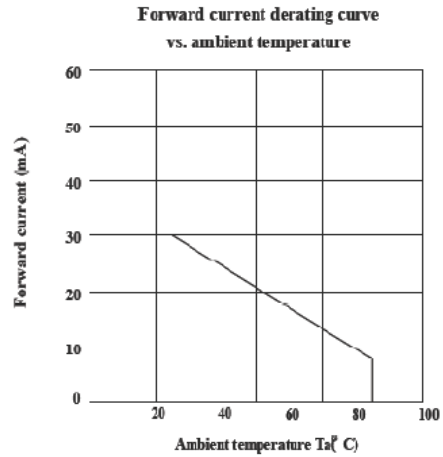
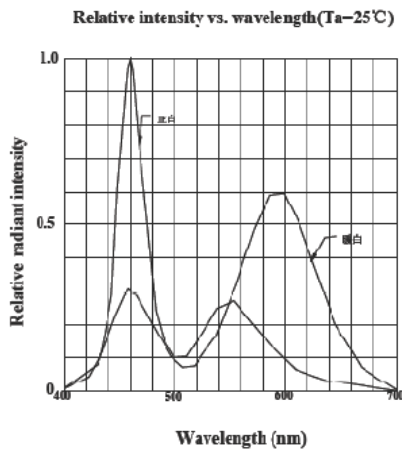



# TOYO LED ELECTRONICS LIMITED

Room 1610, Hong Kong Plaza, 188 Connaught Road West, Hong Kong.

Tel : (852) 2540 7288  
 http://www.toyo-led.com

Fax : (852) 2517 1797  
 E-mail : sales@toyo-led.com



**P/N: TY-L0603CW1(0.40)**

0603 Package 1.6\*0.8mm Surface Mount LEDs Series

## ◇ Reliability Test Items And Conditions

NO.	Item	Test Condition	Test Hr/cycle/time	Sample Q'ty	Ac/Re
1	Reflow	TEMP:260±5°C; Min.5Sec	6 min	22pcs	0/1
2	Temperature Cycle	H:+100°C 15mins To(5mins) L:-40°C 15mins	300 cycles	22pcs	0/1
3	Thermal Shock	H:+100°C 15mins To(5mins) L:-40°C 15mins	300 cycles	22pcs	0/1
4	Low Temperature Storage	TEMP:-40°C	1000hrs	22pcs	0/1
5	DC Operating Life	IF=20MA	1000hrs	22pcs	0/1
6	High Temperature	85°C	1000hrs	22pcs	0/1
7	High Humidity	85%R.H.	1000hrs	22pcs	0/1

## ◇ SMT Reflow Soldering Instructions

Number of reflow process shall be less than 2 times and cooling  
 Process to normal temperature is required between first and second  
 soldering process

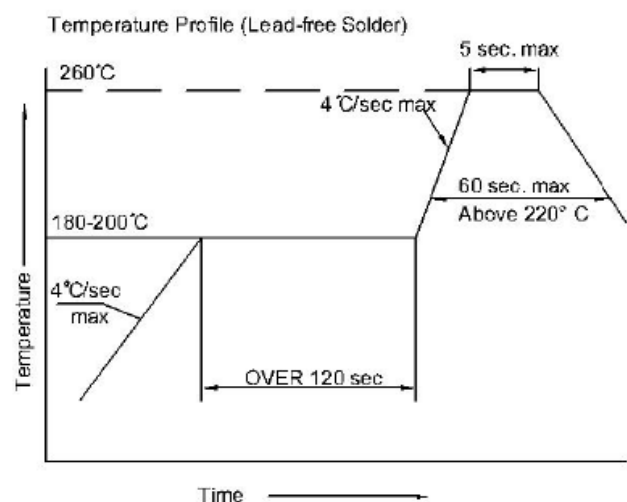
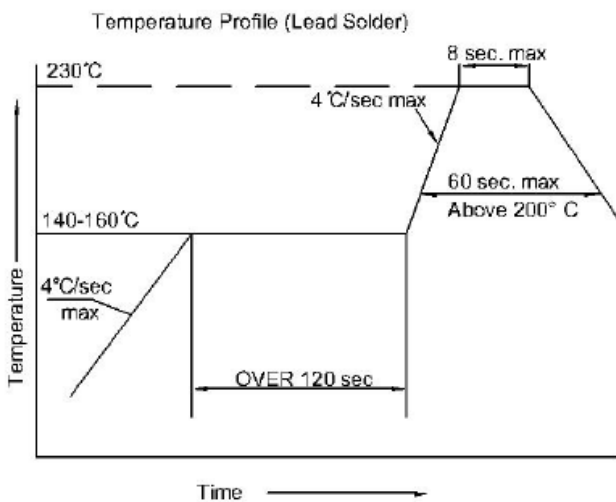



# TOYO LED ELECTRONICS LIMITED

Room 1610, Hong Kong Plaza, 188 Connaught Road West, Hong Kong.  
 Tel : (852) 2540 7288 Fax : (852) 2517 1797  
 http://www.toyo-led.com E-mail : sales@toyo-led.com



**P/N: TY-L0603CW1(0.40)**

0603 Package 1.6\*0.8mm Surface Mount LEDs Series

## ◇ Recommended Soldering Pad Dimensions

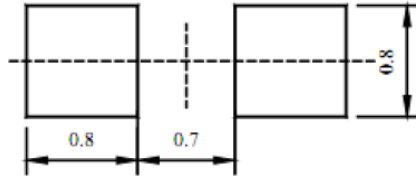

## ◇ Tape Specification: 4,000PCS per reel

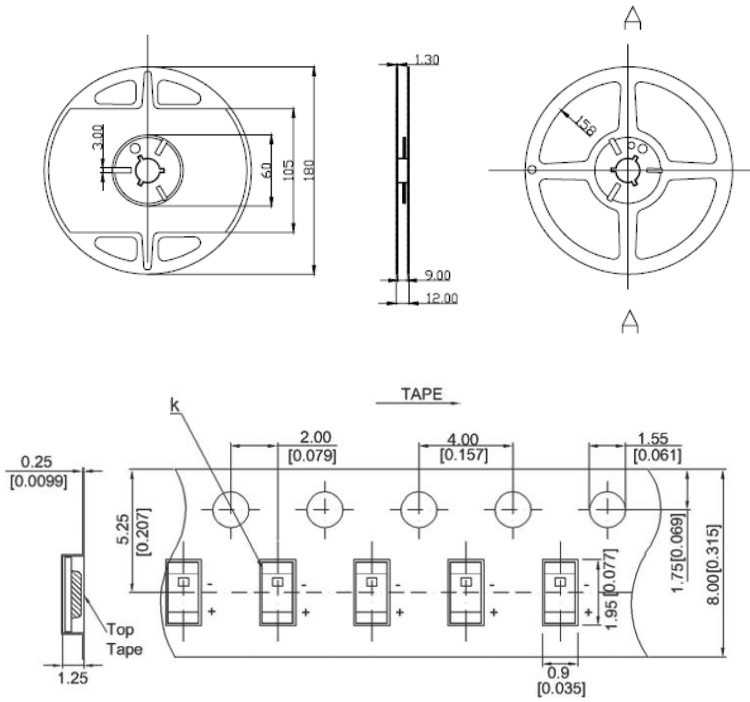

## ◇ Package Label

<b>SMD LED</b>	
PART NO: _____	QA Pass
LOT NO : _____	
Q' TY : _____	
VF : _____ IV : _____	
WL : _____ BIN: _____	Pb
DATA : _____	
TOYO LED ELECTRONICS LIMITED	
Website: http://www.toyo-led.com E-mail: sales@toyo-led.com	



# TOYO LED ELECTRONICS LIMITED

Room 1610, Hong Kong Plaza, 188 Connaught Road West, Hong Kong.

Tel : (852) 2540 7288  
http://www.toyo-led.com

Fax : (852) 2517 1797  
E-mail : sales@toyo-led.com



## P/N: TY-L0603CW1(0.40)

0603 Package 1.6\*0.8mm Surface Mount LEDs Series

### ❖ Package & Shipping Instructions

