



TOYO LED ELECTRONICS LIMITED

Room 1610, Hong Kong Plaza, 188 Connaught Road West, Hong Kong.

Tel: (852) 2540 7288

Fax: (852) 2517 1797

<http://www.toyo-led.com>

[email: sales@toyo-led.com](mailto:sales@toyo-led.com)



P/N: TY-HP5BL-S

High Power Series

PACKAGE DIMENSION

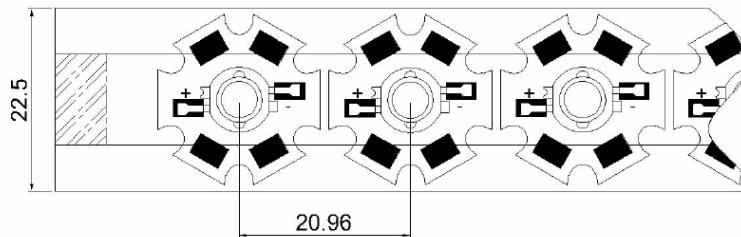
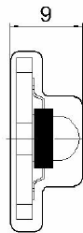
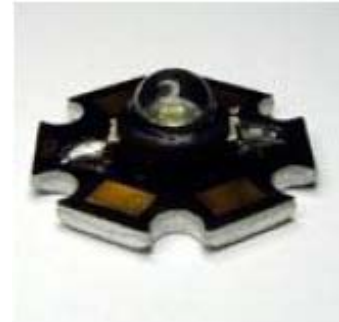
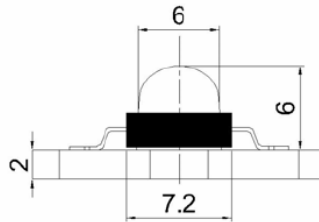
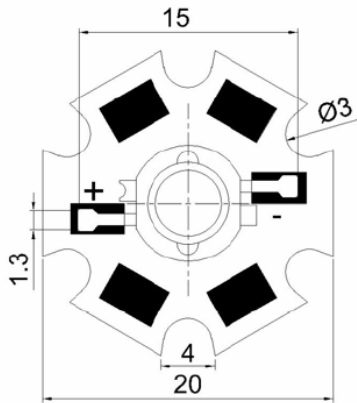

◆ Features

1. Long operating life
2. Highest flux
3. Available in Blue
4. More energy efficient than incandescent and most halogen lamps
5. Low voltage DC operated
6. Cool beam, safe to touch
7. Instant light (less than 100ns)
8. Fully dimmable
9. No UV
10. Superior ESD protection
11. Lower Rth
12. RoHS compliant

◆ Applications

1. Reading lights (cars, buses & aircraft)
2. LCD Backlights/light Guides
3. Fiber optic alternative / Decorative / Entertainment
4. Mini-accent / Up lighters / Down lighters / Orientation
5. Indoor / Outdoor commercial and Residential Architectural
6. Cove / Under shelf / Task
7. Bollards / Security / Garden
8. Portable (flashlight, bicycle)
9. Edge-lit signs (Exit, point of sale)
10. Automotive Exit (Stop-Tail-Turn, CHMSL, Mirror Side Repeat)
11. Traffic signaling / Beacons / Rail Crossing and Wayside

NOTES:

1. All dimensions are in millimeters;
2. Tolerance is ±0.20mm especially other specified;
3. 20pcs / Tube.



TOYO LED ELECTRONICS LIMITED

Room 1610, Hong Kong Plaza, 188 Connaught Road West, Hong Kong.

Tel: (852) 2540 7288

Fax: (852) 2517 1797

<http://www.toyo-led.com>

[email: sales@toyo-led.com](mailto:sales@toyo-led.com)



P/N: TY-HP5BL-S

High Power Series

✧ **Absolute Maximum Ratings(Ta=25C°)**

Item	Symbol	Maximum	Unit
Forward Current	I _F	1.2	A
Peak Forward Current*	I _{FP}	1.3	A
Reverse Voltage	V _R	5	V
Power Dissipation	P _D	5	W
Electrostatic Discharge	ESD	±500	V
Operating Temperature Range	T _{OPR}	-40 ~ +80	°C
Storage Temperature Range	T _{STG}	-40 ~ +100	°C
Lead Soldering Temperature**	T _{SOL}	Max. 260°C for 3sec Max.	

*IFP Conditions: Pulse Width≤10msec duty≤1/10

**All high power emitter LED products mounted on aluminum metal-core PCB, can be lighted directly, but we do not recommend lighting the high power products for more than 5 seconds without a appropriate heat dissipation equipment.

**Re-flow, wave peak and soak-stannum soldering etc. is not suitable for this products.

**Suggest to solder it by professional high power LED soldering machine.

**Can use invariable-temperature searing-iron with soldering condition: ≤260°C less than 3 seconds.

✧ **Electrical / Optical Characteristics(Ta=25C°)**

Item	Symbol	Min.	Typ.	Max.	Unit	Condition
Forward Voltage	V _F	3.0	3.5	4.0	V	I _F =1.2A
Reverse Current	I _R	--	--	50	uA	V _R =5V
50% Power Angle	2θ _{1/2}	110	--	140	deg	I _F =1.2A
Luminous Intensity	Φ _V	25	--	35	lm	I _F =1.2A
Recommend Forward Current	I _F	--	1.2	--	A	--
Chromaticity	T _c	460	--	470	nm	I _F =1.2A
Thermal Resistance, Junction to Case	R _{JP}	--	10	--	°C/w	I _F =1.2A

Notes:

1. Torlerance of measurement of fowward voltage ±0.1V.
2. Torlerance of measurement of peak wavelength ±2.0nm.
3. Torlerance of measurement of luminous intensity ±15%.



TOYO LED ELECTRONICS LIMITED

Room 1610, Hong Kong Plaza, 188 Connaught Road West, Hong Kong.

Tel: (852) 2540 7288

Fax: (852) 2517 1797

<http://www.toyo-led.com>

email: sales@toyo-led.com



P/N: TY-HP5BL-S

High Power Series

Typical Electrical / Optical Characteristics Curves (Ta=25°C)

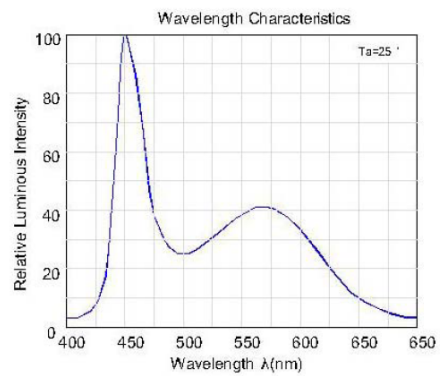
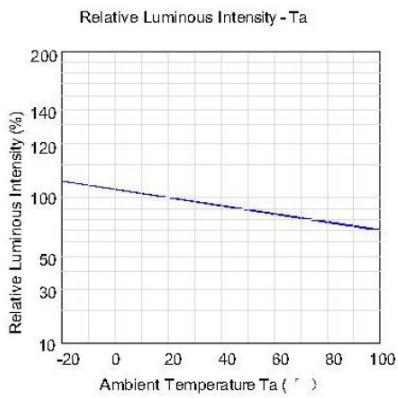
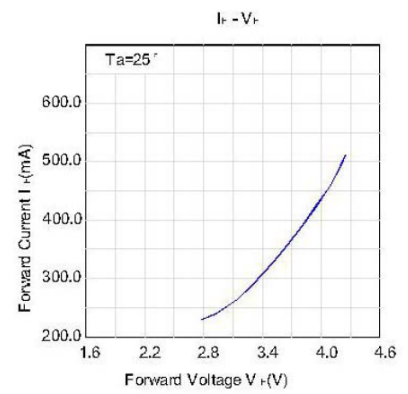
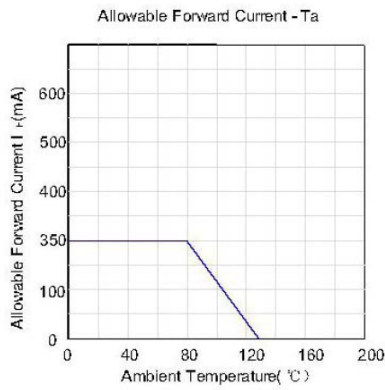
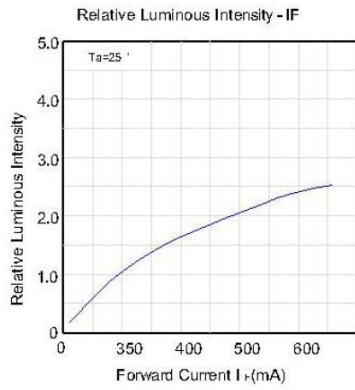

Radiation Pattern

