



# TOYO LED ELECTRONICS LIMITED

Room 1610, Hong Kong Plaza, 188 Connaught Road West, Hong Kong.

Tel: (852) 2540 7288

Fax: (852) 2517 1797

<http://www.toyo-led.com>

[email: sales@toyo-led.com](mailto:sales@toyo-led.com)



## P/N: TY-HP1PG

High Power Series

### PACKAGE DIMENSION

#### Package Dimensions of Device

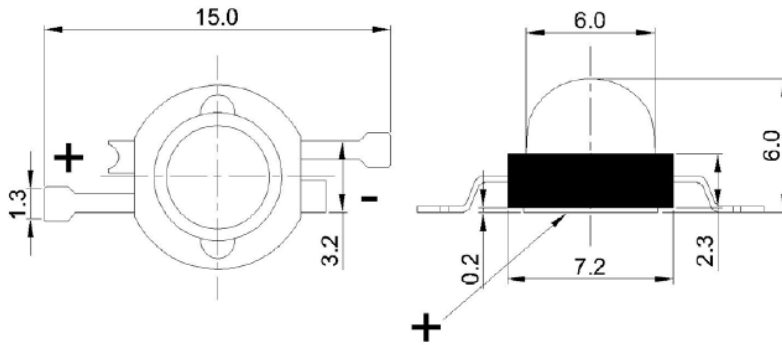

#### Tape Specification: 100pcs per reel

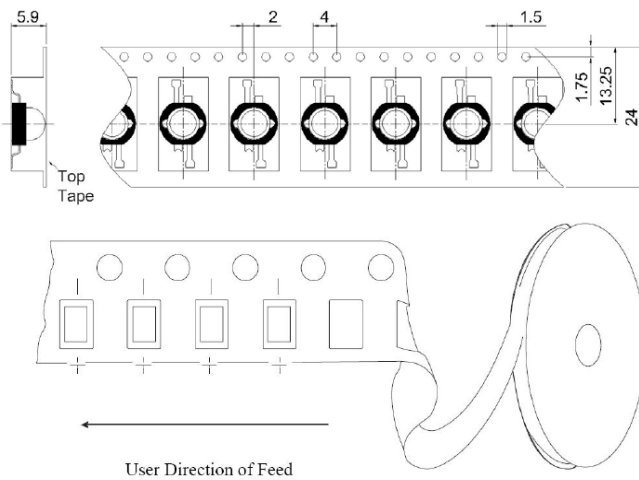

#### NOTES:

1. All dimensions are in millimeters;
2. Tolerance is  $\pm 0.20\text{mm}$  especially other specified.

#### Features

1. Long operating life
2. Highest flux
3. Available in Pure Green
4. Lambertian radiation pattern
5. More energy efficient than incandescent and most halogen lamps
6. Low voltage DC operated
7. Cool beam, safe to touch
8. Instant light (less than 100ns)
9. Fully dimmable
10. No UV
11. Superior ESD protection
12. Eutectic die bonding
13. RoHS compliant

#### Applications

1. Reading lights (cars, buses & aircraft)
2. LCD Backlights/light Guides
3. Fiber optic alternative / Decorative / Entertainment
4. Mini-accent / Up lighters / Down lighters / Orientation
5. Indoor / Outdoor commercial and Residential Architectural
6. Cove / Under shelf / Task
7. Bollards / Security / Garden
8. Portable (flashlight, bicycle)
9. Edge-lit signs (Exit, point of sale)
10. Automotive Exit (Stop-Tail-Turn, CHMSL, Mirror Side Repeat)
11. Traffic signaling / Beacons / Rail Crossing and Wayside



# TOYO LED ELECTRONICS LIMITED

Room 1610, Hong Kong Plaza, 188 Connaught Road West, Hong Kong.

Tel: (852) 2540 7288

Fax: (852) 2517 1797

<http://www.toyo-led.com>

[email: sales@toyo-led.com](mailto:sales@toyo-led.com)



**P/N: TY-HP1PG**

High Power Series

✧ **Absolute Maximum Ratings(Ta=25C°)**

Item	Symbol	Maximum	Unit
Forward Current	I <sub>F</sub>	350	mA
Peak Forward Current*	I <sub>FP</sub>	500	mA
Reverse Voltage	V <sub>R</sub>	5	V
Power Dissipation	P <sub>D</sub>	1000	mW
Electrostatic Discharge	ESD	±500	V
Operating Temperature Range	T <sub>OPR</sub>	-40 ~ +80	°C
Storage Temperature Range	T <sub>STG</sub>	-40 ~ +100	°C
Lead Soldering Temperature**	T <sub>SOL</sub>	Max. 260°C for 3sec Max.	

\*IFP Conditions: Pulse Width≤10msec duty≤1/10

\*\*All high power emitter LED products mounted on aluminum metal-core PCB, can be lighted directly, but we do not recommend lighting the high power products for more than 5 seconds without a appropriate heat dissipation equipment.

\*\*Re-flow, wave peak and soak-stannum soldering etc. is not suitable for this products.

\*\*Suggest to solder it by professional high power LED soldering machine.

\*\*Can use invariable-temperature searing-iron with soldering condition: ≤260°C less than 3 seconds.

✧ **Electrical / Optical Characteristics(Ta=25C°)**

Item	Symbol	Min.	Typ.	Max.	Unit	Condition
Forward Voltage	V <sub>F</sub>	3.0	3.4	3.8	V	I <sub>F</sub> =350mA
Reverse Current	I <sub>R</sub>	--	--	50	uA	V <sub>R</sub> =5V
50% Power Angle	2θ <sub>1/2</sub>	110	--	140	deg	I <sub>F</sub> =350mA
Luminous Intensity	Φ <sub>v</sub>	50	--	60	lm	I <sub>F</sub> =350mA
Recommend Forward Current	I <sub>F</sub>	--	350	--	mA	--
Wavelength	λ <sub>d</sub>	520	--	530	nm	I <sub>F</sub> =350mA
Thermal Resistance, Junction to Case	R <sub>JP</sub>	--	10	--	°C/w	I <sub>F</sub> =350mA

Notes:

1. Torlerance of measurement of foward voltage ±0.1V.
2. Torlerance of measurement of peak wavelength ±2.0nm.
3. Torlerance of measurement of luminous intensity ±15%.



# TOYO LED ELECTRONICS LIMITED

Room 1610, Hong Kong Plaza, 188 Connaught Road West, Hong Kong.

Tel: (852) 2540 7288

Fax: (852) 2517 1797

<http://www.toyo-led.com>

email: [sales@toyo-led.com](mailto:sales@toyo-led.com)



**P/N: TY-HP1PG**

High Power Series

## Typical Electrical / Optical Characteristics Curves (Ta=25°C)

Relative Luminous Intensity - IF

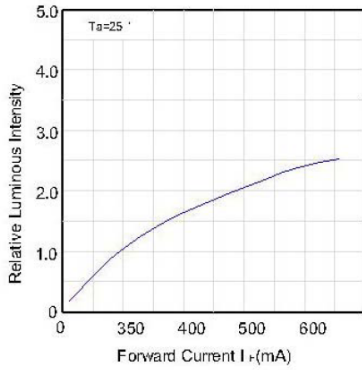

Allowable Forward Current - Ta

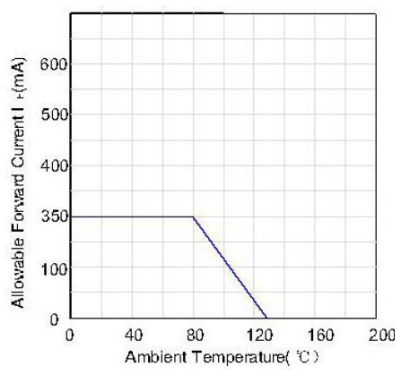

I\_f - V\_f

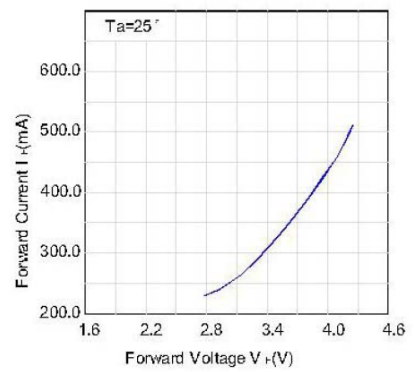

Relative Luminous Intensity - Ta

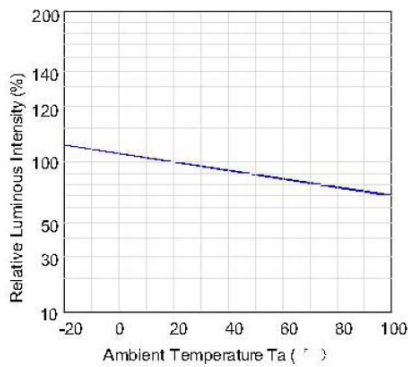

Wavelength Characteristics

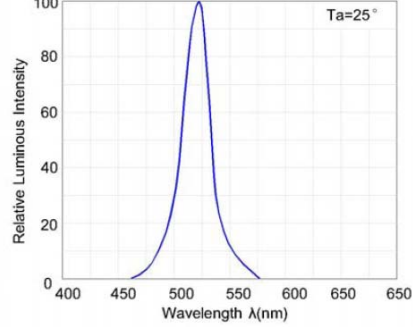

## Radiation Pattern

