



# TOYO LED ELECTRONICS LIMITED

Room 1610, Hong Kong Plaza, 188 Connaught Road West, Hong Kong.

Tel : (852) 2540 7288  
http://www.toyo-led.com

Fax : (852) 2517 1797  
E-mail : sales@toyo-led.com



## P/N: TY-F5050PW60W8-12-720-WPE

### ✧ Features:

- LED Flexible Strips with 60 LEDs per meter
- PLCC-2 package for single LED package
- waterproof with epoxy
- Ultra Bright Pure White as Source Color
- Available on reel
- 12V DC Voltage
- Water-proofing IP63

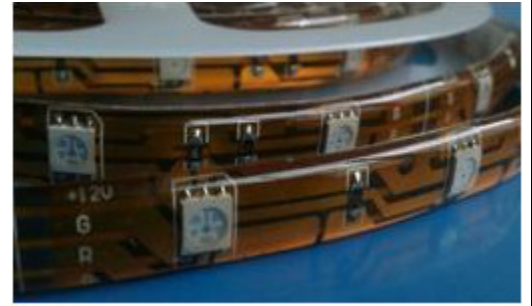

### ✧ Description

- The Pure White source color devices are made with InGaN on sapphire
- Light Emitting Diode as implied in single package

### ✧ Application

- General use
- Reveal display for hotel, commercial building, stage, bar, outdoor environment
- Declaration lighting
- Indoor lighting
- Shop-window decoration

### ✧ Physical Dimensions

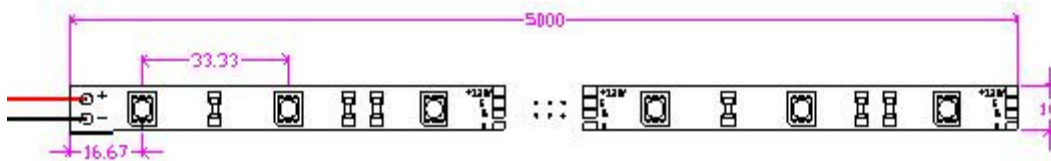

Packing for single LED

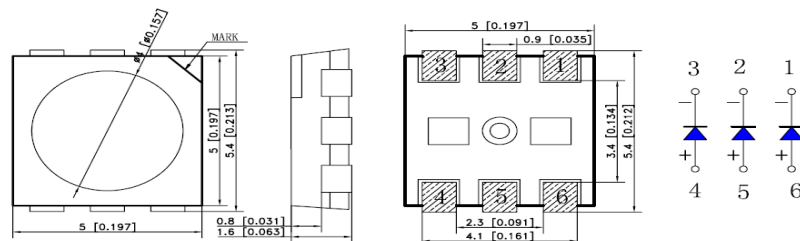

### NOTES:

1. All dimensions are in millimeter[unit];
2. Tolerance is  $\pm 0.2\text{mm}$  (0.008 ") especially other specified;
3. Specifications are subject to change without notice.
4. IP63 : protection from : 6 : Dust tight-- No ingress of dust; complete protection against contact  
3 : Spraying water -- Water falling as a spray at any angle up to  $60^\circ$  from the vertical shall have no harmful effect.



# TOYO LED ELECTRONICS LIMITED

Room 1610, Hong Kong Plaza, 188 Connaught Road West, Hong Kong.

Tel : (852) 2540 7288  
http://www.toyo-led.com

Fax : (852) 2517 1797  
E-mail : sales@toyo-led.com



**P/N: TY-F5050PW60W8-12-720-WPE**

## ◇ Schematic Drawing

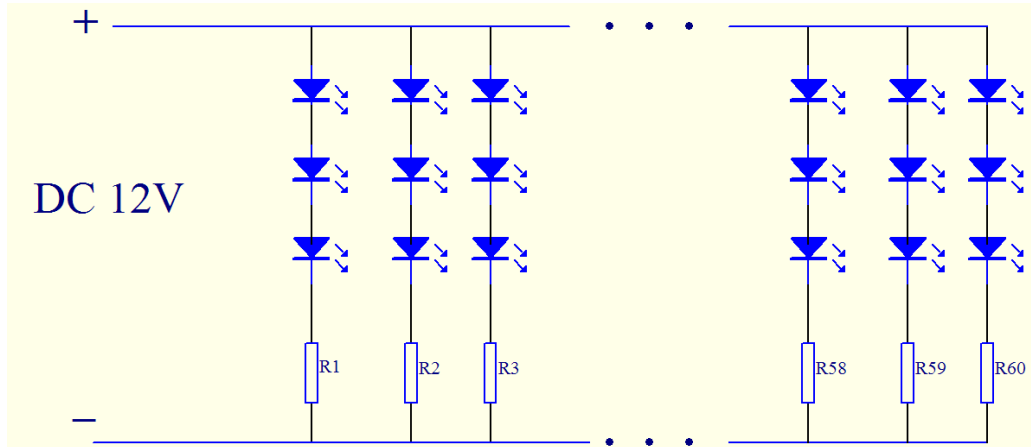

## ◇ Absolute Maximum Ratings(Ta=25°C)

| Item                        | Symbol           | Maximum   | Unit |
|-----------------------------|------------------|-----------|------|
| Power Dissipation           | PD               | 14.4      | W    |
| Continuous Forward Current  | I <sub>F</sub>   | 1200      | mA   |
| Operating Temperature Range | T <sub>opr</sub> | -10 to+40 | °C   |
| Storage Temperature Range   | T <sub>stg</sub> | -10 to+40 | °C   |

## ◇ Electrical/Optical Characteristics(Ta=25°C)

| Item                      | Symbol            | Condition              | Min. | Typ. | Max  | Unit |
|---------------------------|-------------------|------------------------|------|------|------|------|
| Forward Voltage           | V <sub>F</sub>    | I <sub>F</sub> =1200mA | --   | 12   | --   | V    |
| Luminous Flux             | Φ                 | I <sub>F</sub> =1200mA | --   | 720  | --   | lm   |
| Color Temperature         | C <sub>T</sub>    | I <sub>F</sub> =1200mA | 5000 | 6000 | 7000 | K    |
| Viewing Angle             | 2θ <sub>1/2</sub> | I <sub>F</sub> =1200mA | --   | 120  | --   | Deg  |
| Recommend Forward Current | I <sub>F</sub>    | --                     | --   | 1200 | --   | mA   |

Remarks:

All Electrical and Optical characteristics are based on reference of single LED package.



# TOYO LED ELECTRONICS LIMITED

Room 1610, Hong Kong Plaza, 188 Connaught Road West, Hong Kong.

Tel : (852) 2540 7288  
http://www.toyo-led.com

Fax : (852) 2517 1797  
E-mail : sales@toyo-led.com



**P/N: TY-F5050PW60W8-12-720-WPE**

## ❖ Tape Specification: 5 Meters per reel

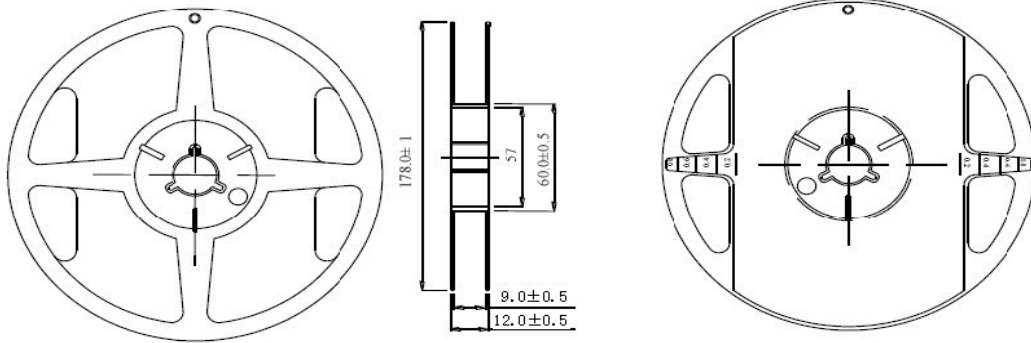

## ❖ Package Label

| LED Strips .   |         |
|--|---------|
| PART NO: _____   | QA Pass |
| LOT NO : _____   |         |
| Q' TY : _____  | Pb      |
| VF : _____ ΦV: _____   |         |
| TC : _____ WLD: _____  |         |
| DATE : _____   |         |
| <b>TOYO LED ELECTRONICS LIMITED</b><br>Website: <a href="http://www.toyo-led.com">http://www.toyo-led.com</a> E-mail: <a href="mailto:sales@toyo-led.com">sales@toyo-led.com</a> |         |



# TOYO LED ELECTRONICS LIMITED

Room 1610, Hong Kong Plaza, 188 Connaught Road West, Hong Kong.

Tel : (852) 2540 7288  
http://www.toyo-led.com

Fax : (852) 2517 1797  
E-mail : sales@toyo-led.com



**P/N: TY-F5050PW60W8-12-720-WPE**

## Package & Shipping Instructions



Label

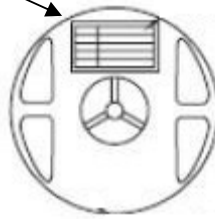

5 Meters/Reel



ANTI-STATIC BAGS

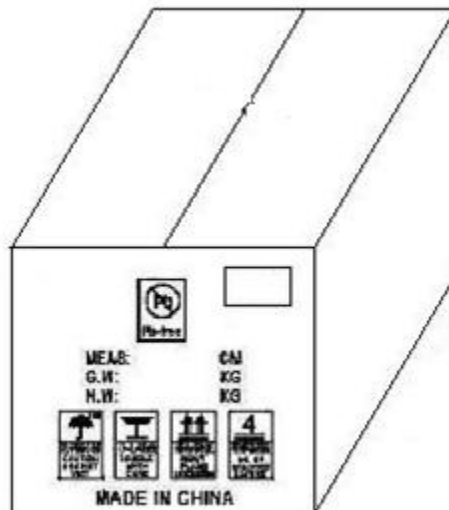

60 reels / Box (300 Meters)  
Size: 480 x 390 x 260(mm)