



# TOYO LED ELECTRONICS LIMITED

Room 1610, Hong Kong Plaza, 188 Connaught Road West, Hong Kong.

Tel : (852) 2540 7288  
http://www.toyo-led.com

Fax : (852) 2517 1797  
E-mail : sales@toyo-led.com



## P/N: TY-F3528UY60W8-12-65-WPP

### ✧ Features:

- LED Flexible Strips with 60 LEDs per meter
- PLCC-2 package for single LED package
- waterproof with PVC
- Ultra Bright Yellow as Source Color
- Available on reel
- 12V DC Voltage
- Water-proofing IP68

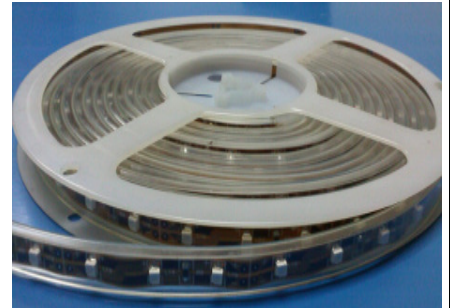

### ✧ Description

- The Yellow source color devices are made with InGaAlP on sapphire
- Light Emitting Diode as implied in single package

### ✧ Application

- General use
- Reveal display for hotel, commercial building, stage, bar, outdoor environment
- Declaration lighting
- Indoor lighting
- Shop-window decoration

### ✧ Physical Dimensions

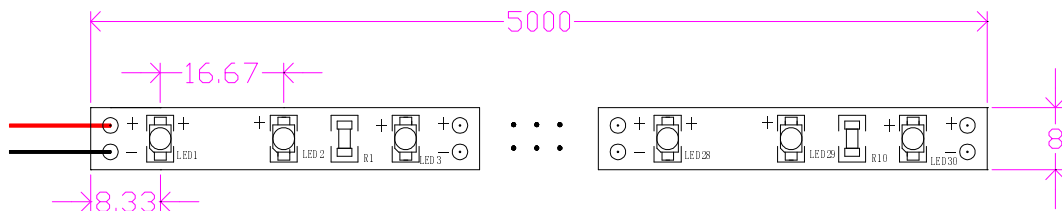

Packing for single LED

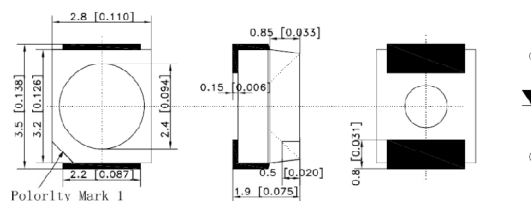

### NOTES:

1. All dimensions are in millimeter[unit];
2. Tolerance is  $\pm 0.2\text{mm}$  (0.008 ") especially other specified;
3. Specifications are subject to change without notice.
4. IP68 : protection from : 6 : Dust tight-- No ingress of dust; complete protection against contact  
8:Immersion beyond 1 m--The equipment is suitable for continuous immersion in water.



# TOYO LED ELECTRONICS LIMITED

Room 1610, Hong Kong Plaza, 188 Connaught Road West, Hong Kong.  
 Tel : (852) 2540 7288 Fax : (852) 2517 1797  
 http://www.toyo-led.com E-mail : sales@toyo-led.com



**P/N: TY-F3528UY60W8-12-65-WPP**

## ◇ Schematic Drawing

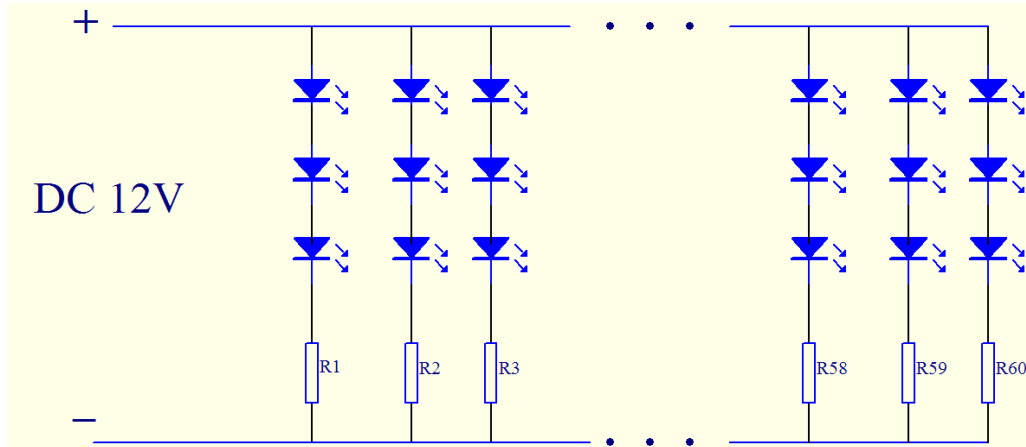

## ◇ Absolute Maximum Ratings(Ta=25°C)

Item	Symbol	Maximum	Unit
Power Dissipation	PD	4.8	W
Continuous Forward Current	I <sub>F</sub>	400	mA
Operating Temperature Range	T <sub>opr</sub>	-10 to+40	°C
Storage Temperature Range	T <sub>stg</sub>	-10 to+40	°C

## ◇ Electrical/Optical Characteristics(Ta=25°C)

Item	Symbol	Condition	Min.	Typ.	Max	Unit
Forward Voltage	V <sub>F</sub>	I <sub>F</sub> =400mA	--	12	--	V
Luminous Flux	Φ	I <sub>F</sub> =400mA	--	65	--	lm
Wavelength	λ	I <sub>F</sub> =400mA	585	592	595	nm
Viewing Angle	2θ <sub>1/2</sub>	I <sub>F</sub> =400mA	--	120	--	Deg
Recommend Forward Current	I <sub>F</sub>	--	--	400	--	mA

Remarks:

All Electrical and Optical characteristics are based on reference of single LED package.



# TOYO LED ELECTRONICS LIMITED

Room 1610, Hong Kong Plaza, 188 Connaught Road West, Hong Kong.

Tel : (852) 2540 7288  
http://www.toyo-led.com

Fax : (852) 2517 1797  
E-mail : sales@toyo-led.com



## P/N: TY-F3528UY60W8-12-65-WPP

### ✧ Tape Specification: 5 Meters per reel

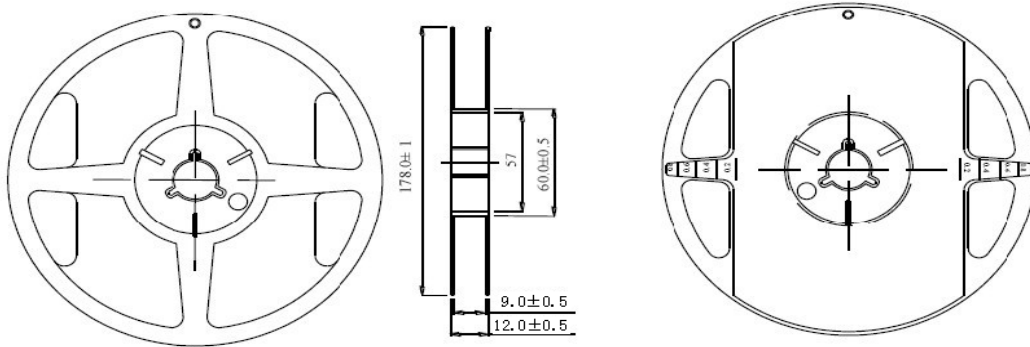

### ✧ Package Label

LED Strips . .	
PART NO: _____	QA Pass
LOT NO : _____	
Q' TY : _____	
VF : _____ ΦV: _____	Pb
TC : _____ VLD: _____	
DATE : _____	
<b>TOYO LED ELECTRONICS LIMITED</b> Website: <a href="http://www.toyo-led.com">http://www.toyo-led.com</a> E-mail: <a href="mailto:sales@toyo-led.com">sales@toyo-led.com</a>	



# TOYO LED ELECTRONICS LIMITED

Room 1610, Hong Kong Plaza, 188 Connaught Road West, Hong Kong.

Tel : (852) 2540 7288  
http://www.toyo-led.com

Fax : (852) 2517 1797  
E-mail : sales@toyo-led.com



**P/N: TY-F3528UY60W8-12-65-WPP**

## Package & Shipping Instructions



Label

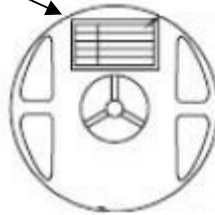

5 Meters/Reel



ANTI-STATIC BAGS

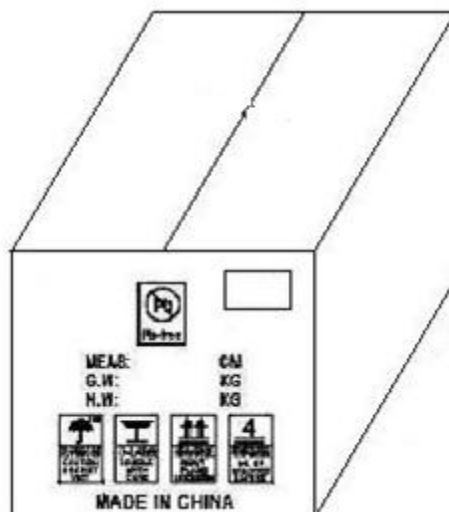

60 reels / Box (300 Meters)  
Size: 480 x 390 x 260(mm)