



TOYO LED ELECTRONICS LIMITED

Room 1610, Hong Kong Plaza, 188 Connaught Road West, Hong Kong.

Tel : (852) 2540 7288
http://www.toyo-led.com

Fax : (852) 2517 1797
E-mail : sales@toyo-led.com



P/N: TY-F3528PW60W8-12-220-WPS

✧ Features:

- LED Flexible Strips with 60 LEDs per meter
- PLCC-2 package for single LED package
- waterproof with silicon
- Ultra Bright Pure White as Source Color
- Available on reel
- 12V DC Voltage
- Water-proofing IP65

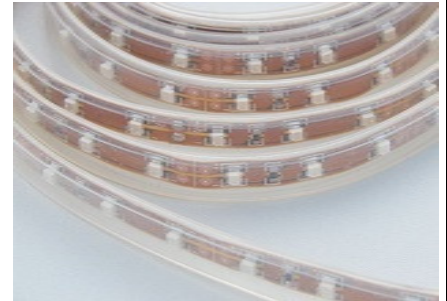

✧ Description

- The Pure White source color devices are made with InGaN on sapphire
- Light Emitting Diode as implied in single package

✧ Application

- General use
- Reveal display for hotel, commercial building, stage, bar, outdoor environment
- Declaration lighting
- Indoor lighting
- Shop-window decoration

✧ Physical Dimensions

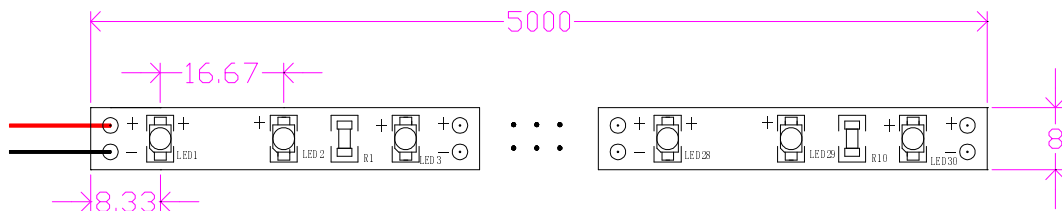

Packing for single LED

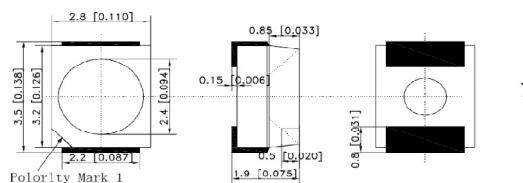

NOTES:

1. All dimensions are in millimeter[unit];
2. Tolerance is $\pm 0.2\text{mm}$ (0.008 ") especially other specified;
3. Specifications are subject to change without notice.
4. IP65 : protection from : 6 : Dust tight-- No ingress of dust; complete protection against contact
5: Water jets -- Water projected by a nozzle (6.3mm) against enclosure from any direction shall have no harmful effects.



TOYO LED ELECTRONICS LIMITED

Room 1610, Hong Kong Plaza, 188 Connaught Road West, Hong Kong.
 Tel : (852) 2540 7288 Fax : (852) 2517 1797
 http://www.toyo-led.com E-mail : sales@toyo-led.com



P/N: TY-F3528PW60W8-12-220-WPS

◇ Schematic Drawing

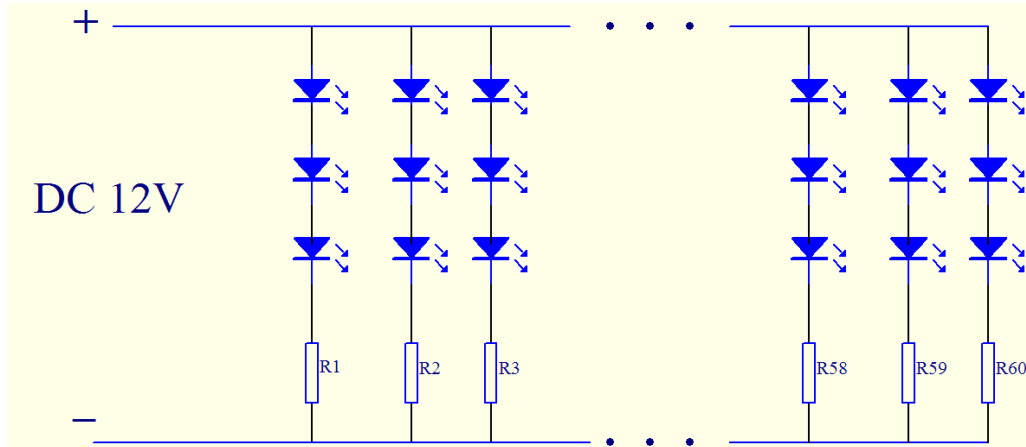

◇ Absolute Maximum Ratings(Ta=25°C)

Item	Symbol	Maximum	Unit
Power Dissipation	PD	4.8	W
Continuous Forward Current	I _F	400	mA
Operating Temperature Range	T _{opr}	-10 to+40	°C
Storage Temperature Range	T _{stg}	-10 to+40	°C

◇ Electrical/Optical Characteristics(Ta=25°C)

Item	Symbol	Condition	Min.	Typ.	Max	Unit
Forward Voltage	V _F	I _F =400mA	--	12	--	V
Luminous Flux	Φ	I _F =400mA	--	220	--	lm
Color Temperature	C _r	I _F =400mA	5000	6000	7000	K
Viewing Angle	2θ _{1/2}	I _F =400mA	--	120	--	Deg
Recommend Forward Current	I _F	--	--	400	--	mA

Remarks:

All Electrical and Optical characteristics are based on reference of single LED package.



TOYO LED ELECTRONICS LIMITED

Room 1610, Hong Kong Plaza, 188 Connaught Road West, Hong Kong.

Tel : (852) 2540 7288
http://www.toyo-led.com

Fax : (852) 2517 1797
E-mail : sales@toyo-led.com



P/N: TY-F3528PW60W8-12-220-WPS

✧ Tape Specification: 5 Meters per reel

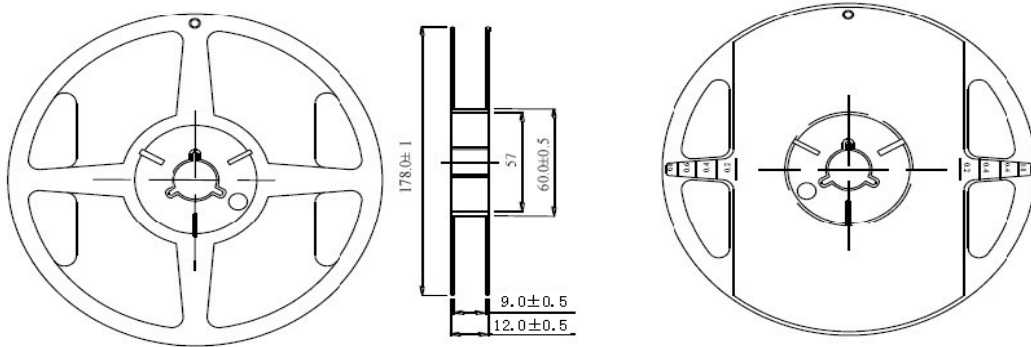

✧ Package Label

LED Strips . .	
PART NO: _____	QA Pass
LOT NO : _____	
Q' TY : _____	Pb
VF : _____ ΦV: _____	
TC : _____ VLD: _____	
DATE : _____	
TOYO LED ELECTRONICS LIMITED Website: http://www.toyo-led.com E-mail: sales@toyo-led.com	



TOYO LED ELECTRONICS LIMITED

Room 1610, Hong Kong Plaza, 188 Connaught Road West, Hong Kong.

Tel : (852) 2540 7288
http://www.toyo-led.com

Fax : (852) 2517 1797
E-mail : sales@toyo-led.com



P/N: TY-F3528PW60W8-12-220-WPS

Package & Shipping Instructions



Label

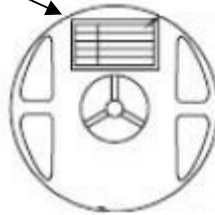

5 Meters/Reel



ANTI-STATIC BAGS

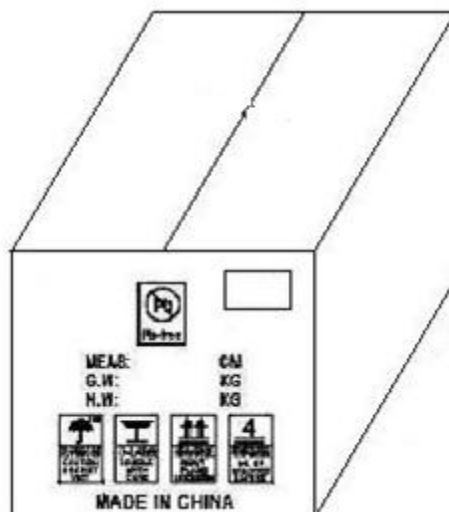

60 reels / Box (300 Meters)
Size: 480 x 390 x 260(mm)