



TOYO LED ELECTRONICS LIMITED

Room 1610, Hong Kong Plaza, 188 Connaught Road West, Hong Kong.
Tel : (852) 2540 7288 Fax : (852) 2517 1797
http://www.toyo-led.com E-mail : sales@toyo-led.com



P/N: TY-3528WW1

3.5 * 2.8mm TOP SMD Series

✧ Features:

- 3.5mm×2.8mm SMT LED, 1.90mm thickness
- PLCC-2 package
- White package
- Suitable for all SMT assembly and solder process
- Available on tape and reel



✧ Description

The Warm White source color devices are made with InGaN on sapphire Light Emitting Diode.

✧ Application

- Optical indicator
- Indicator and backlighting in telephone and fax
- Flat backlight for LCD, switch and symbol
- Light pipe application
- General use

✧ Package Dimensions

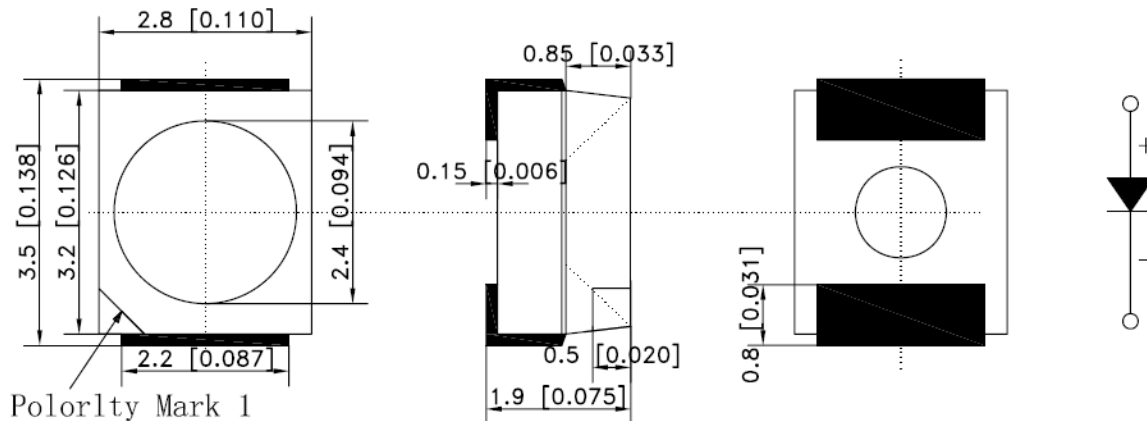

NOTES:

1. All dimensions are in millimeter[unit];
2. Tolerance is $\pm 0.2\text{mm}$ (0.008 ") especially other specified;
3. Specifications are subject to change without notice.



TOYO LED ELECTRONICS LIMITED

Room 1610, Hong Kong Plaza, 188 Connaught Road West, Hong Kong.
 Tel : (852) 2540 7288 Fax : (852) 2517 1797
 http://www.toyo-led.com E-mail : sales@toyo-led.com



P/N: TY-3528WW1

3.5 * 2.8mm TOP SMD Series

Part No.	Emitted Color	Len's Color	Chip Material
TY-3528WW1	Warm White	Yellow	InGaN

✧ Absolute Maximum Ratings(Ta=25°C)

Item	Symbol	Maximum	Unit
Power Dissipation	PD	110	mW
Continuous Forward Current	I _{Fmax}	30	mA
Peak Forward Current(1/10 Duty Cycle 0.1ms Pulse Width)	I _{FP}	100	mA
Peverse Voltage	V _R	5	V
Operating Temperature Range	T _{opr}	-40 to+85	25°C
Storage Temperature Range	T _{stg}	-40 to+85	25°C

✧ Electrical/Optical Characteristics(Ta=25°C)

Item	Symbol	Condition	Min.	Typ.	Max	Unit
Forward Voltage	V _F	I _F =20mA	2.9	3.2	3.4	V
Luminous Intensity	I _v	I _F =20mA	1350	1600	--	mcd
Luminous Flux	Φ	I _F =20mA	3.5	5.2	--	lm
Typical Correlated Color Temperature	T _c	I _F =20mA	2500	3000	3500	K
Chromaticity Coordinates	X	I _F =20mA	--	0.45	--	--
	Y	I _F =20mA	--	0.43	--	--
Viewing Angle	2θ _{1/2}	I _F =20mA	--	120	--	Deg
Capacitance	C	V _F =0V, f=1MHZ	--	100	--	pF
Reverse Current	I _R	V _R =5V	--	5	10	uA



TOYO LED ELECTRONICS LIMITED

Room 1610, Hong Kong Plaza, 188 Connaught Road West, Hong Kong.
Tel : (852) 2540 7288 Fax : (852) 2517 1797
http://www.toyo-led.com E-mail : sales@toyo-led.com



P/N: TY-3528WW1

3.5 * 2.8mm TOP SMD Series

◇ Typical Electro-Optical Characteristics Curves

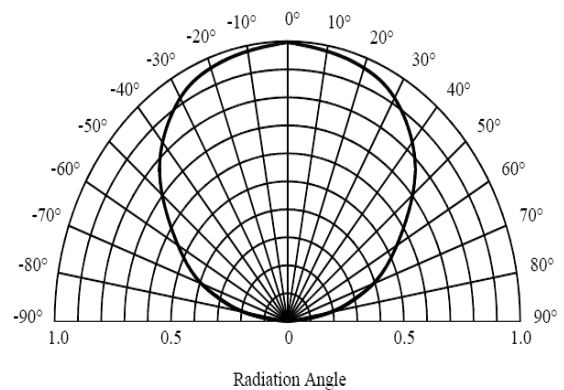
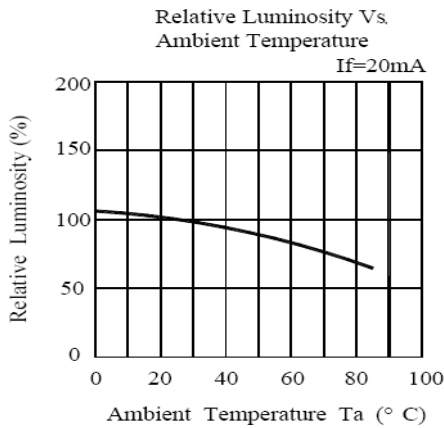
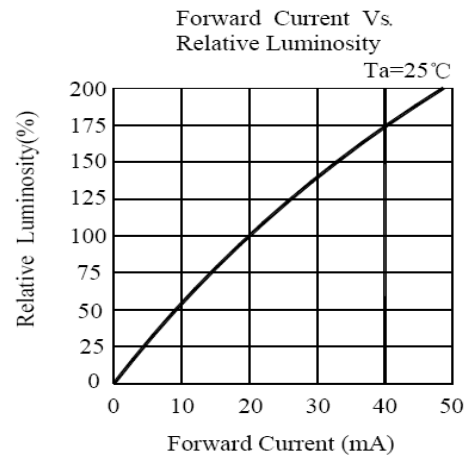
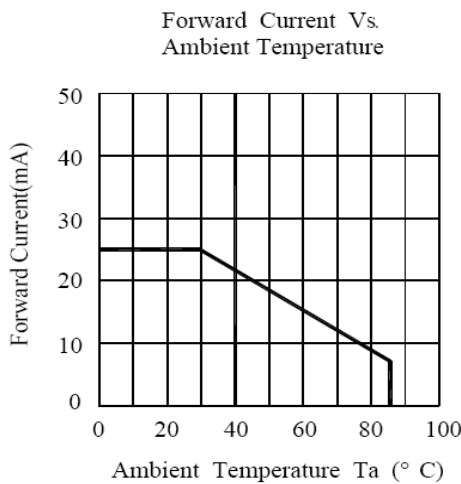
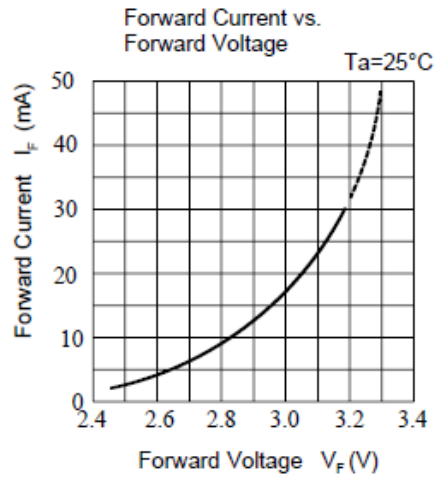
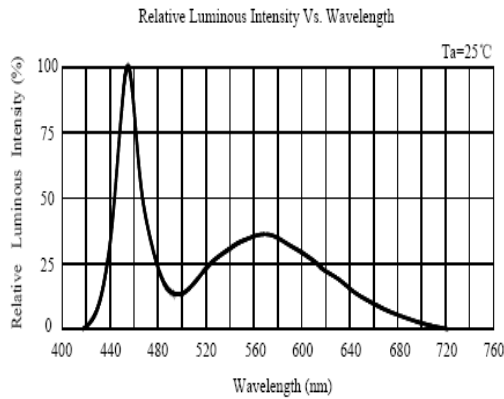



TOYO LED ELECTRONICS LIMITED

Room 1610, Hong Kong Plaza, 188 Connaught Road West, Hong Kong.
 Tel : (852) 2540 7288 Fax : (852) 2517 1797
 http://www.toyo-led.com E-mail : sales@toyo-led.com



P/N: TY-3528WW1

3.5 * 2.8mm TOP SMD Series

◇ Reliability Test Items And Conditions

NO.	Item	Test Condition	Test Hr/cycle/time	Sample Q'ty	Ac/Re
1	Reflow	TEMP:260±5°C; Min.5Sec	6 min	22pcs	0/1
2	Temperature Cycle	H:+100°C 15mins To(5mins) L:-40°C 15mins	300 cycles	22pcs	0/1
3	Thermal Shock	H:+100°C 15mins To(5mins) L:-40°C 15mins	300 cycles	22pcs	0/1
4	High Temperature Storage	TEMP:+260°C	1000hrs	22pcs	0/1
5	Low Temperature Storage	TEMP:-40°C	1000hrs	22pcs	0/1
6	DC Operating Life	IF=20MA	1000hrs	22pcs	0/1
7	High Temperature	85°C	1000hrs	22pcs	0/1
8	High Humidity	85%R.H.	1000hrs	22pcs	0/1

◇ SMT Reflow Soldering Instructions

Number of reflow process shall be than 2 times and cooling
 Process to normal temperature is required between first and second
 soldering process

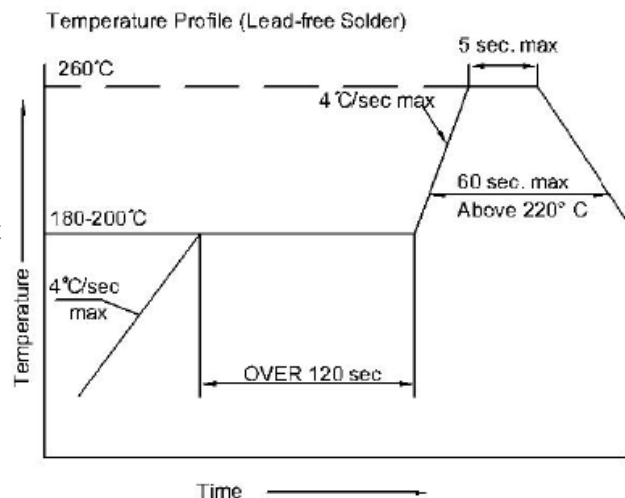
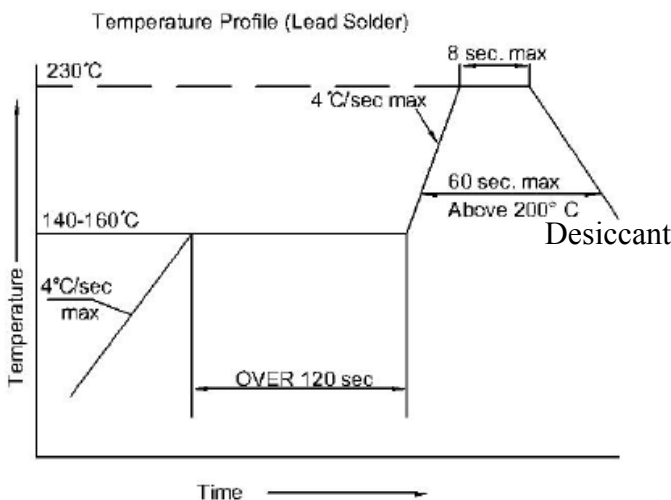



TOYO LED ELECTRONICS LIMITED

Room 1610, Hong Kong Plaza, 188 Connaught Road West, Hong Kong.
Tel : (852) 2540 7288 Fax : (852) 2517 1797
http://www.toyo-led.com E-mail : sales@toyo-led.com



P/N: TY-3528WW1

3.5 * 2.8mm TOP SMD Series

Recommended Soldering Pad Dimensions

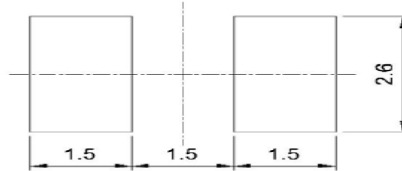

Tape Specification: 2,000PCS per reel

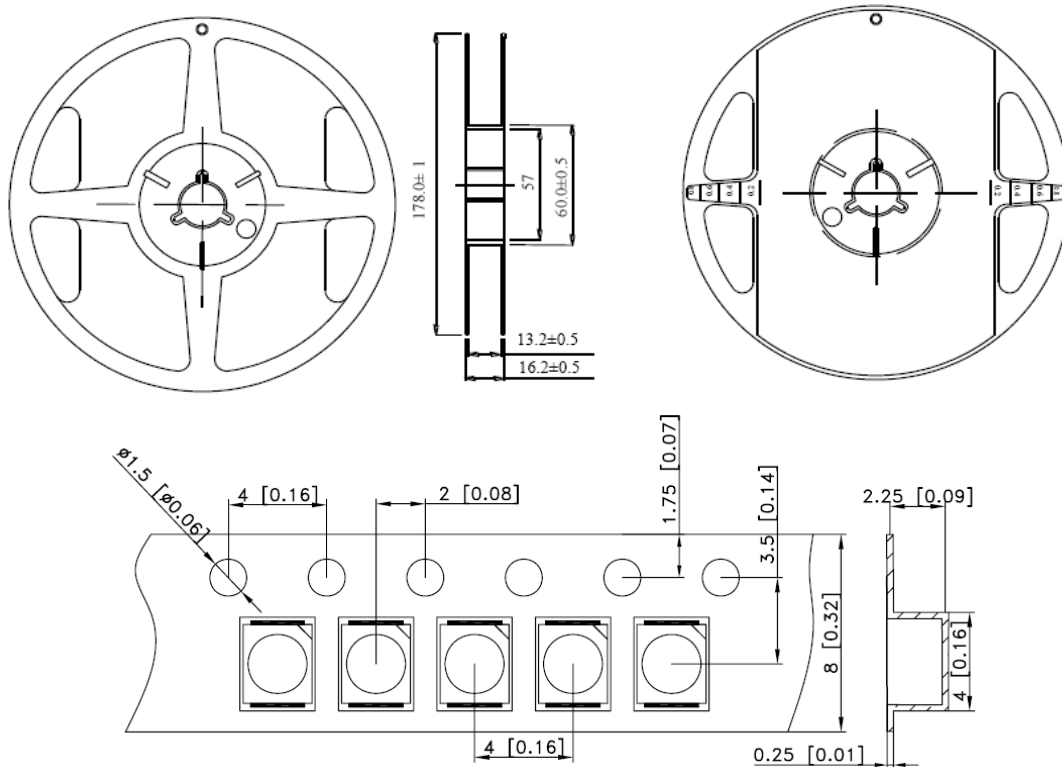

Package Label

SMD LED	
PART NO: _____	QA Pass
LOT NO : _____	
Q' TY : _____	
VF : _____ IV : _____	
TC : _____ BIN: _____	Pb
DATA : _____	
TOYO LED ELECTRONICS LIMITED	
Website: http://www.toyo-led.com E-mail: sales@toyo-led.com	



TOYO LED ELECTRONICS LIMITED

Room 1610, Hong Kong Plaza, 188 Connaught Road West, Hong Kong.
Tel : (852) 2540 7288 Fax : (852) 2517 1797
http://www.toyo-led.com E-mail : sales@toyo-led.com



P/N: TY-3528WW1

3.5 * 2.8mm TOP SMD Series

✧ Package & Shipping Instructions

