



# TOYO LED ELECTRONICS LIMITED

Room 1610, Hong Kong Plaza, 188 Connaught Road West, Hong Kong.  
Tel : (852) 2540 7288 Fax : (852) 2517 1797  
http://www.toyo-led.com E-mail : sales@toyo-led.com



## P/N: TY-3528UR2

3.5 \* 2.8mm TOP SMD Series

### ✧ Features:

- 3.5mm×2.8mm SMT LED, 1.90mm thickness
- PLCC-2 package
- White package
- Suitable for all SMT assembly and solder process
- Available on tape and reel



### ✧ Description

The Red source color devices are made with AlGaInP on sapphire Light Emitting Diode.

### ✧ Application

- Optical indicator
- Indicator and backlighting in telephone and fax
- Flat backlight for LCD, switch and symbol
- Light pipe application
- General use

### ✧ Package Dimensions

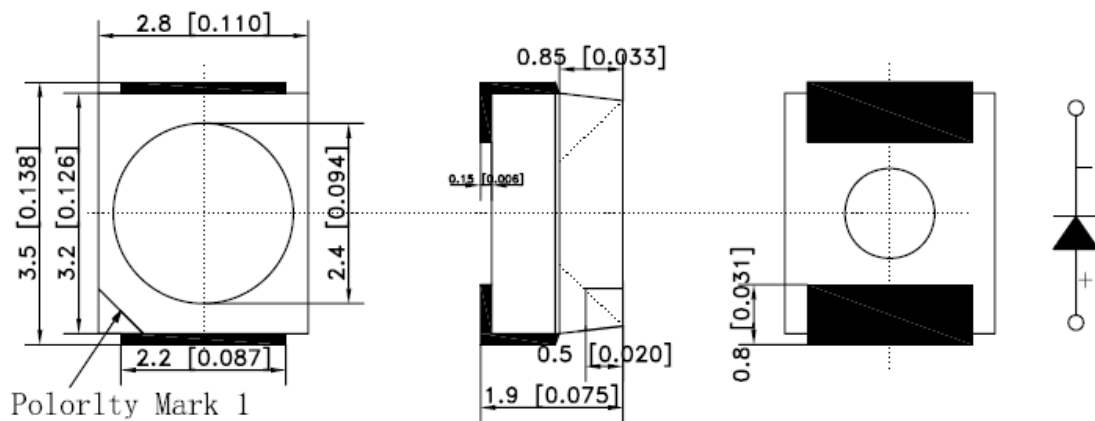

### NOTES:

1. All dimensions are in millimeter[unit];
2. Tolerance is  $\pm 0.2\text{mm}$  (0.008 ") especially other specified;
3. Specifications are subject to change without notice.



# TOYO LED ELECTRONICS LIMITED

Room 1610, Hong Kong Plaza, 188 Connaught Road West, Hong Kong.  
 Tel : (852) 2540 7288 Fax : (852) 2517 1797  
 http://www.toyo-led.com E-mail : sales@toyo-led.com



## P/N: TY-3528UR2

3.5 \* 2.8mm TOP SMD Series

Part No.	Emitted Color	Len's Color	Chip Material
TY-3528UR2	Red	Water clear	AlGaInP

### ✧ Absolute Maximum Ratings(Ta=25°C)

Item	Symbol	Maximum	Unit
Power Dissipation	PD	110	mW
Continuous Forward Current	I <sub>Fmax</sub>	30	mA
Peak Forward Current(1/10 Duty Cycle 0.1ms Pulse Width)	I <sub>FP</sub>	150	mA
Peverse Voltage	V <sub>R</sub>	5	V
Operating Temperature Range	T <sub>opr</sub>	-40 to+85	25°C
Storage Temperature Range	T <sub>stg</sub>	-40 to+85	25°C

### ✧ Electrical/Optical Characteristics(Ta=25°C)

Item	Symbol	Condition	Min.	Typ.	Max	Unit
Forward Voltage	V <sub>F</sub>	I <sub>F</sub> =20mA	1.9	2.2	2.4	V
Luminous Intensity	I <sub>v</sub>	I <sub>F</sub> =20mA	300	450	--	mcd
Luminous Flux	Φ	I <sub>F</sub> =20mA	1.0	1.5	--	lm
Wavelength	λ	I <sub>F</sub> =20mA	620	625	630	nm
Typical Correlated Color Temperature	T <sub>c</sub>	I <sub>F</sub> =20mA	--	1500	--	K
Chromaticity Coordinates	X	I <sub>F</sub> =20mA	--	--	--	--
	Y	I <sub>F</sub> =20mA	--	--	--	--
Viewing Angle	2θ <sub>1/2</sub>	I <sub>F</sub> =20mA	--	120	--	Deg
Capacitance	C	V <sub>F</sub> =0V, f=1MHZ	--	110	--	pF
Reverse Current	I <sub>R</sub>	V <sub>R</sub> =5V	--	5	10	uA



# TOYO LED ELECTRONICS LIMITED

Room 1610, Hong Kong Plaza, 188 Connaught Road West, Hong Kong.  
 Tel : (852) 2540 7288 Fax : (852) 2517 1797  
 http://www.toyo-led.com E-mail : sales@toyo-led.com



**P/N: TY-3528UR2**

3.5 \* 2.8mm TOP SMD Series

## ◇ Typical Electro-Optical Characteristics Curves

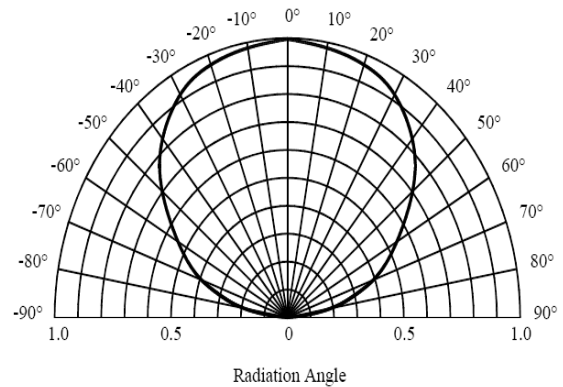
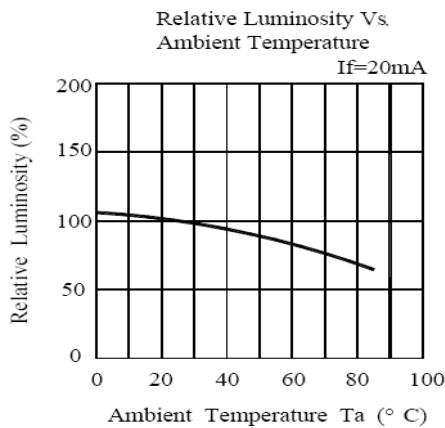
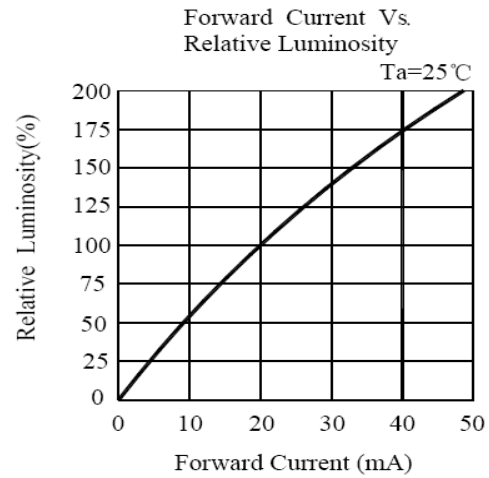
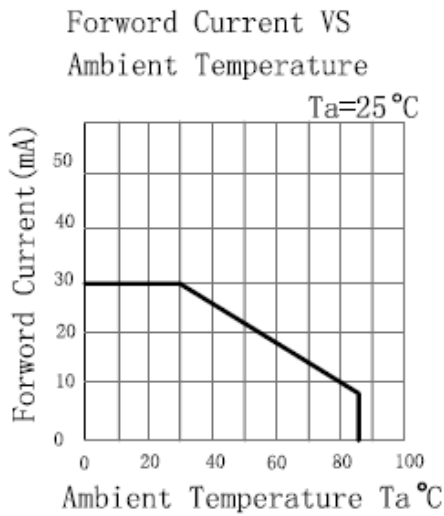
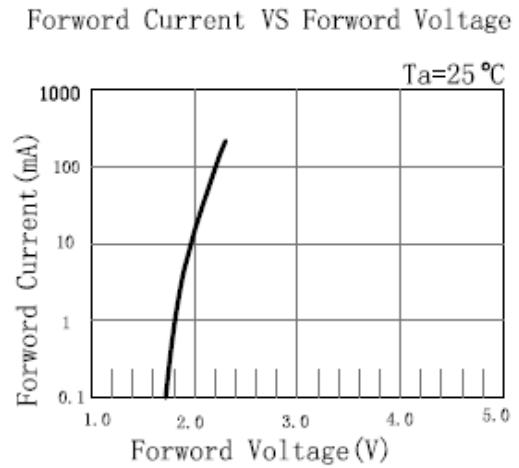
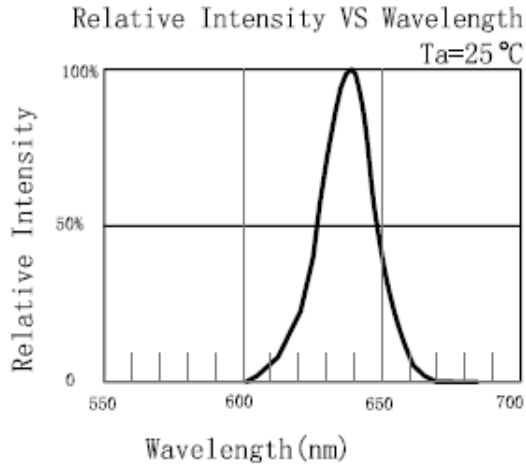



# TOYO LED ELECTRONICS LIMITED

Room 1610, Hong Kong Plaza, 188 Connaught Road West, Hong Kong.  
 Tel : (852) 2540 7288 Fax : (852) 2517 1797  
 http://www.toyo-led.com E-mail : sales@toyo-led.com



**P/N: TY-3528UR2**

3.5 \* 2.8mm TOP SMD Series

## ◇ Reliability Test Items And Conditions

NO.	Item	Test Condition	Test Hr/cycle/time	Sample Q'ty	Ac/Re
1	Reflow	TEMP:260±5°C; Min.5Sec	6 min	22pcs	0/1
2	Temperature Cycle	H:+100°C 15mins To(5mins) L:-40°C 15mins	300 cycles	22pcs	0/1
3	Thermal Shock	H:+100°C 15mins To(5mins) L:-40°C 15mins	300 cycles	22pcs	0/1
4	High Temperature Storage	TEMP:+260°C	1000hrs	22pcs	0/1
5	Low Temperature Storage	TEMP:-40°C	1000hrs	22pcs	0/1
6	DC Operating Life	IF=20MA	1000hrs	22pcs	0/1
7	High Temperature	85°C	1000hrs	22pcs	0/1
8	High Humidity	85%R.H.	1000hrs	22pcs	0/1

## ◇ SMT Reflow Soldering Instructions

Number of reflow process shall be than 2 times and cooling  
 Process to normal temperature is required between first and second  
 soldering process

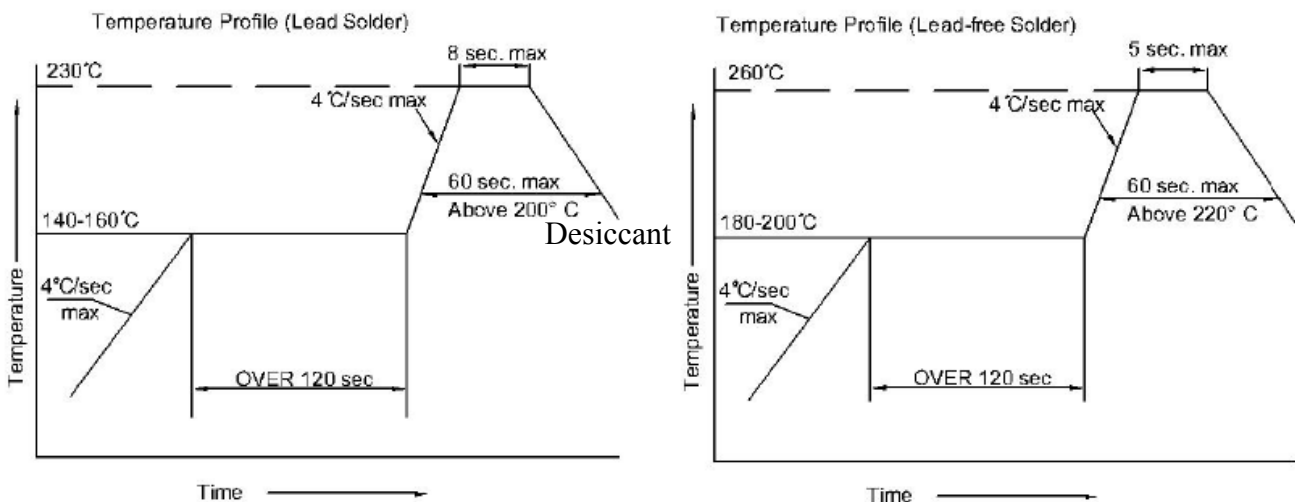



# TOYO LED ELECTRONICS LIMITED

Room 1610, Hong Kong Plaza, 188 Connaught Road West, Hong Kong.  
Tel : (852) 2540 7288 Fax : (852) 2517 1797  
http://www.toyo-led.com E-mail : sales@toyo-led.com



P/N: TY-3528UR2

3.5 \* 2.8mm TOP SMD Series

### ❖ Recommended Soldering Pad Dimensions

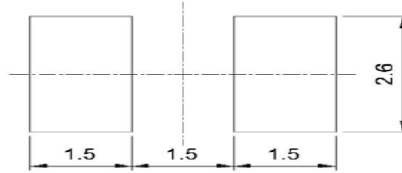

### ❖ Tape Specification: 2,000PCS per reel

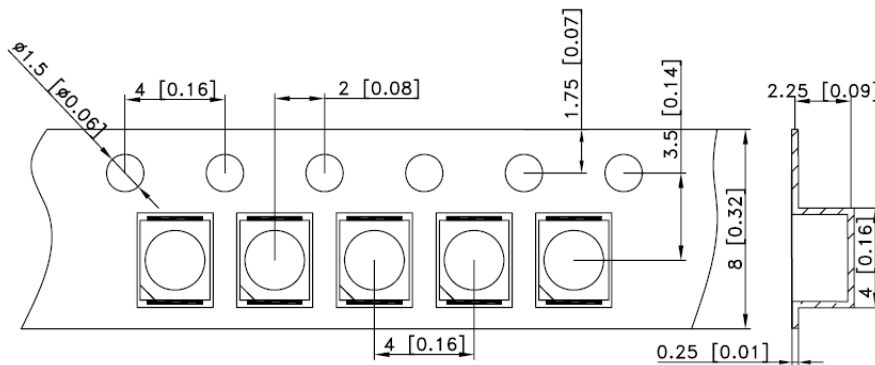
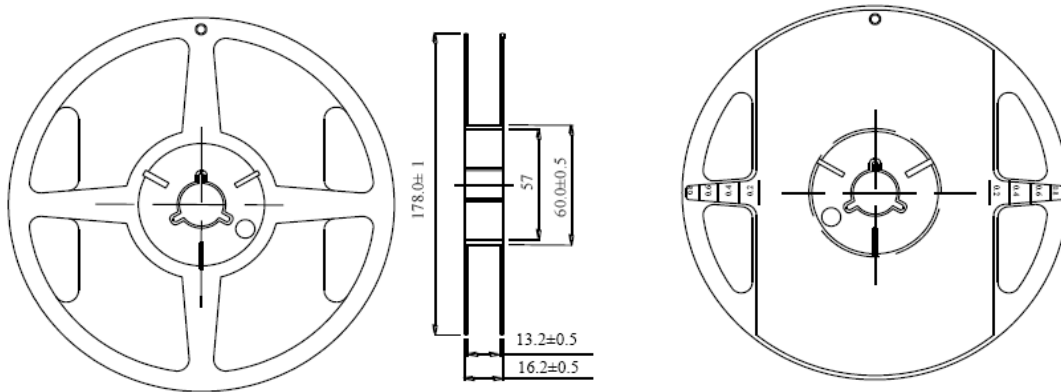

### ❖ Package Label

<b>SMD LED</b>	
PART NO: _____	QA Pass
LOT NO : _____	
Q' TY : _____	
VF : _____ IV : _____	
WL : _____ BIN: _____	Pb
DATA : _____	
TOYO LED ELECTRONICS LIMITED	
Website: <a href="http://www.toyo-led.com">http://www.toyo-led.com</a> E-mail: <a href="mailto:sales@toyo-led.com">sales@toyo-led.com</a>	



# TOYO LED ELECTRONICS LIMITED

Room 1610, Hong Kong Plaza, 188 Connaught Road West, Hong Kong.  
Tel : (852) 2540 7288 Fax : (852) 2517 1797  
http://www.toyo-led.com E-mail : sales@toyo-led.com



**P/N: TY-3528UR2**

3.5 \* 2.8mm TOP SMD Series

## ❖ Package & Shipping Instructions

