



TOYO LED ELECTRONICS LIMITED

Room 1610, Hong Kong Plaza, 188 Connaught Road West, Hong Kong.

Tel : (852) 2540 7288
Http://www.toyo-led.com

Fax : (852) 2517 1797
E-mail : sales@toyo-led.com



P/N: TY-306HY1D60-15H

3 mm Round Type LEDs Series

SPECIFICATION FOR CUSTOMER APPROVAL

P/N:TY-306HY1D60-15H

DATE : February 21, 2014

PREPARED BY : Yanguoliang

CONFIRMED BY :

PLEASE CONFIRM & SIGN BACK THIS SHEET TO US

CUSTOMER: _____
(COMPANY CHOP)

APPROVAL BY: _____
(SIGNATURE)



TOYO LED ELECTRONICS LIMITED

Room 1610, Hong Kong Plaza, 188 Connaught Road West, Hong Kong.

Tel : (852) 2540 7288
 Http://www.toyo-led.com

Fax : (852) 2517 1797
 E-mail : sales@toyo-led.com



P/N: TY-306HY1D60-15H

3 mm Round Type LEDs Series

PACKAGE DIMENSION

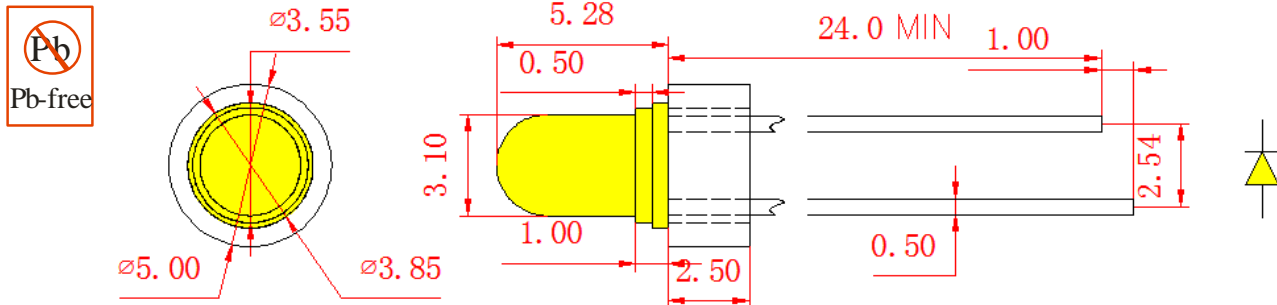

Selection Guide

Part No.	Dice		Lens Color	Iv(mcd)(If=20mA)			Viewing Angle (2θ½)
	Raw Material	Emitted Color		MIN	TYP	MAX	
TY-306HY1D60-15H	AlGaInP	Yellow	YellowDiffused	5	15	-	60 °

Absolute Maximum Ratings(Ta=25C °)

Item	Symbol	Maximum	Unit
Power Dissipation	PD	62	mW
Peak Forward Current (1/10 Duty Cycle 0.1ms Pulse Width)	IFP	140	mA
Continuous Forward Current	IFmax	25	mA
Reverse Voltage	VR	5	V
Capacitance	C	20	pF
Operating / Storage Temperature Range	Topr / Tstg	-40 °C to +85 °C	
Lead Solder Temperature	Tsol	260 °C for 3 seconds	

Electrical / Optical Characteristics(Ta=25C °)

Item	Symbol	Min.	Typ.	Max.	Unit	Condition
Peak Wavelength	λp	-	588	-	nm	IF=20mA
Dominant Wavelength	λd	580	585	595	nm	IF=20mA
Forward Voltage	VF	1.8	2.2	2.6	V	IF=20mA
Reverse Current	IR	-	-	10	uA	VR=5V

NOTES:

- All dimensions are in millimeter(inch);
- Tolerance is ±0.25mm(0.01") unless other specified; Luminous intensity tolerance is ±10%;
- Dominant Emission Wavelength tolerance is ±5%; Specifications are subject to change without notice.



P/N: TY-306HY1D60-15H

3 mm Round Type LEDs Series

■ Typical Electro-Optical Characteristic Curve:

FIG. 1 Forward Current Vs. Forward Voltage

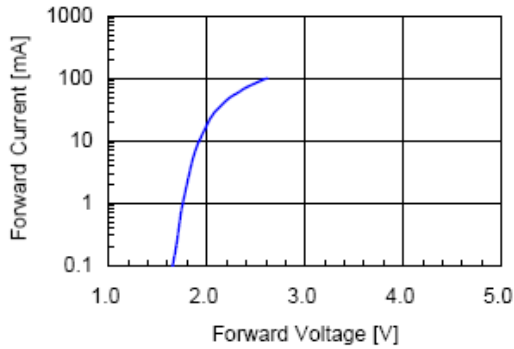

FIG. 2 Relative Intensity Vs. Forward Current

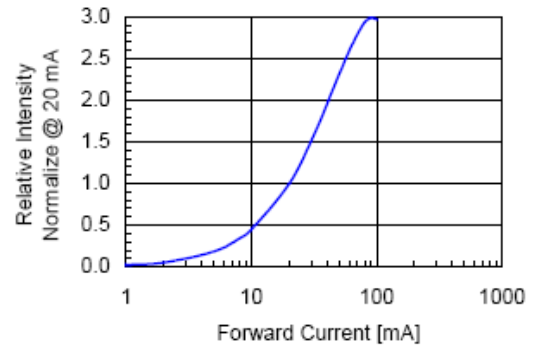

FIG. 3 Forward Voltage Vs. Temperature

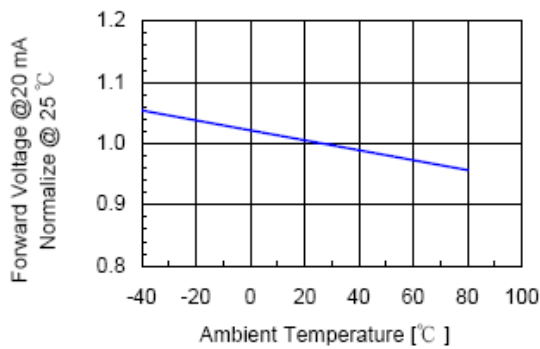

FIG. 4 Relative Intensity Vs. Temperature

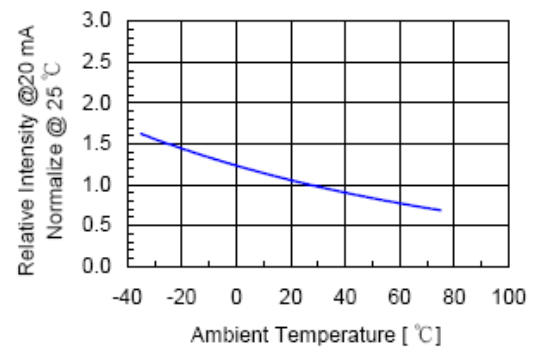
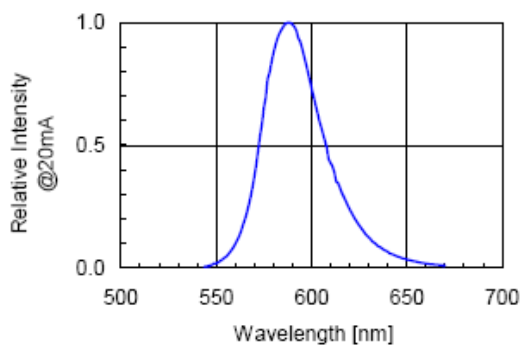

FIG. 5 Relative Intensity Vs. Wavelength





TOYO LED ELECTRONICS LIMITED

Room 1610, Hong Kong Plaza, 188 Connaught Road West, Hong Kong.

Tel : (852) 2540 7288
Http://www.toyo-led.com

Fax : (852) 2517 1797
E-mail : sales@toyo-led.com



P/N: TY-306HY1D60-15H

3 mm Round Type LEDs Series

BULK & PACKING DIMENSIONS

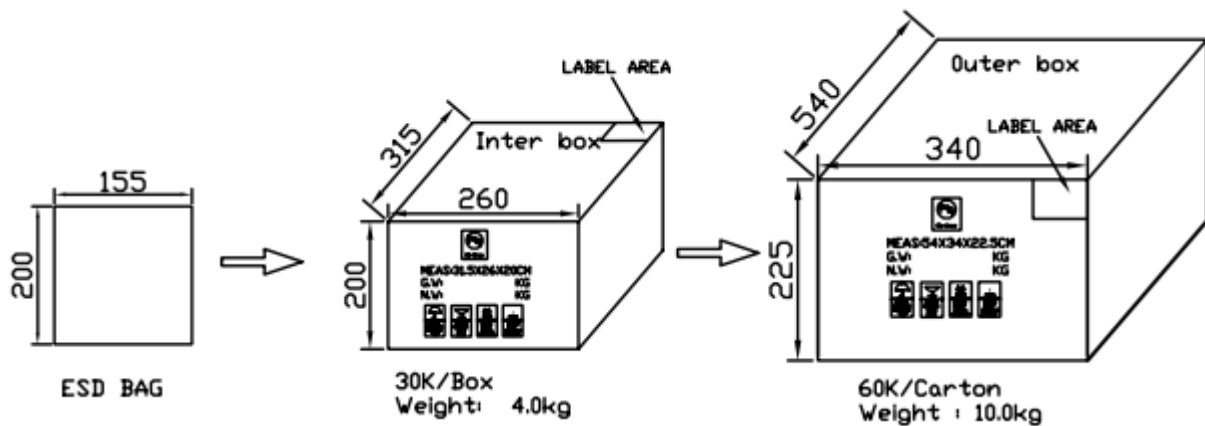

Notes:

1. All dimension are in millimeter (inches);
2. Tolerance is $\pm 0.25\text{mm}$ (0.01") unless otherwise specified.
3. Not recommend to solder within 3mm from the resin.
4. Any kind of LEDs can be made in taped & reel.