



# TOYO LED ELECTRONICS LIMITED

<http://www.toyo-led.com>

e-mail: [sales@toyo-led.com](mailto:sales@toyo-led.com)

## PACKAGE DIMENSION

E10802

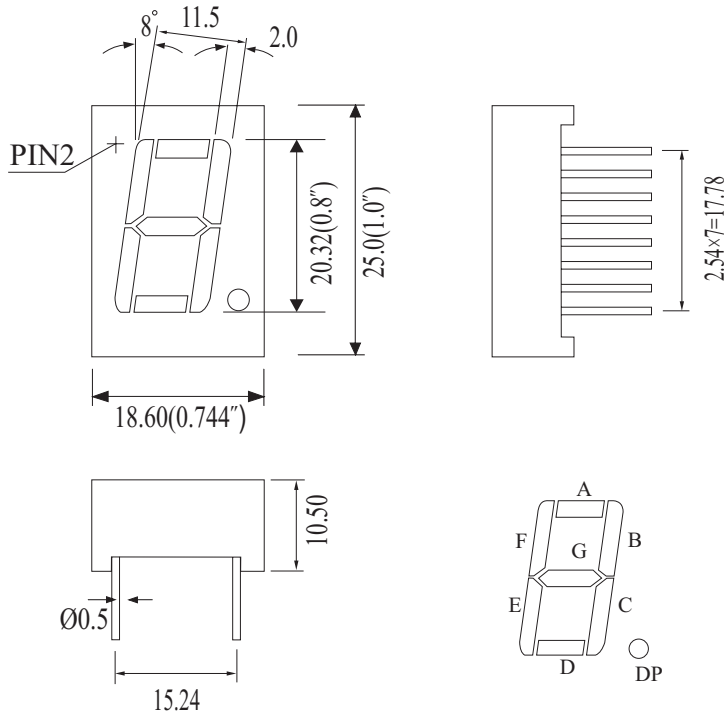

UNIT: MM(INCH) TOLERANCE: ±0.25(0.01")

## INTERNAL CIRCUIT DIAGRAM

